

# RV281

Controllable anti-pollution check valve EA type  
with union connectors

## APPLICATION

Check valves of this type are for use as an independent means of preventing reverse water flow and for installing directly after a water meter on central water supply systems. They can also be used for industrial, commercial and similar systems where back pressure, back flow and back syphonage must be prevented. The classifications of appliances to meet these requirements are specified in EN 1717.

## APPROVALS

- DVGW
- SVGW

## SPECIAL FEATURES

- Universal application
- Suitable for installation in any position
- Creates no shock pressure loadings
- Union connectors simplify service
- Low pressure loss
- Fully approved for noise level protection to class 1
- All materials are UBA conform

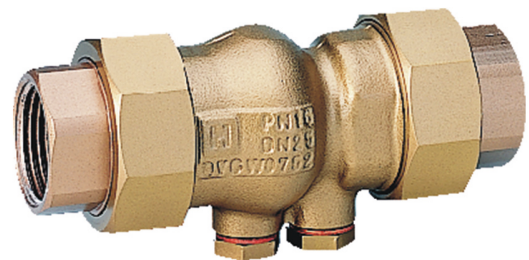

## TECHNICAL DATA

Media	
Medium:	Drinking water
Connections/Sizes	
Connection size:	1/2" - 2"
Pressure values	
Max. operating pressure:	16 bar
Opening pressure:	ca. 0.05 bar
Operating temperatures	
Max. operating temperature medium:	65 °C accord. DIN EN 13959 (short term up to 90 °C)
Specifications	
Liquid category:	2 (no hazardous materials)

## CONSTRUCTION

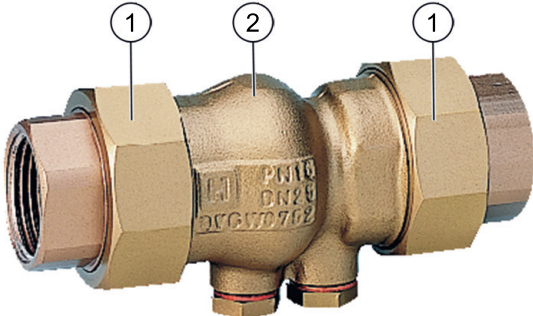
Overview	Components	Materials
	<b>1</b> Threaded or soldered union connectors	Red bronze threaded connections (only for 1/2" and 1 1/4") or brass threaded connections
	<b>2</b> Housing with test and drain plugs (1/2" device with test plugs only)	Brass
<b>Not depicted components</b>		
	Check valve insert	High-grade synthetic material
	Test and drain plugs	Brass
	Disc guide	High-grade synthetic material
	Spring	Stainless steel
	Disc with lip seal ring	EPDM

## METHOD OF OPERATION

Spring loaded check valves have a moving seal disc which is lifted off the seat by a greater or lesser amount depending on the flow rate through the valve. If the flow falls towards zero, then the spring pushes the disc back onto the seat and seals the waterway.

To ensure continuing correct function it is recommended that check valves be regularly checked and maintained (as specified in EN 1717).

## TRANSPORTATION AND STORAGE

Keep parts in their original packaging and unpack them shortly before use.

The following parameters apply during transportation and storage:

Parameter	Value
Environment:	clean, dry and dust free
Min. ambient temperature:	5 °C
Max. ambient temperature:	55 °C
Min. ambient relative humidity:	25 % *
Max. ambient relative humidity	85 % *

\*non condensing

## INSTALLATION GUIDELINES

### Setup requirements

- Install in horizontal pipework with test and drain plug downwards
  - This position is best for draining
- Install shut-off valves
  - Shut-off valves provide optimal serviceability
- Ensure good access
  - Simplifies maintenance and inspection
- Install right after water meter if applicable
  - Protects against backflow from water systems

**Installation Example**

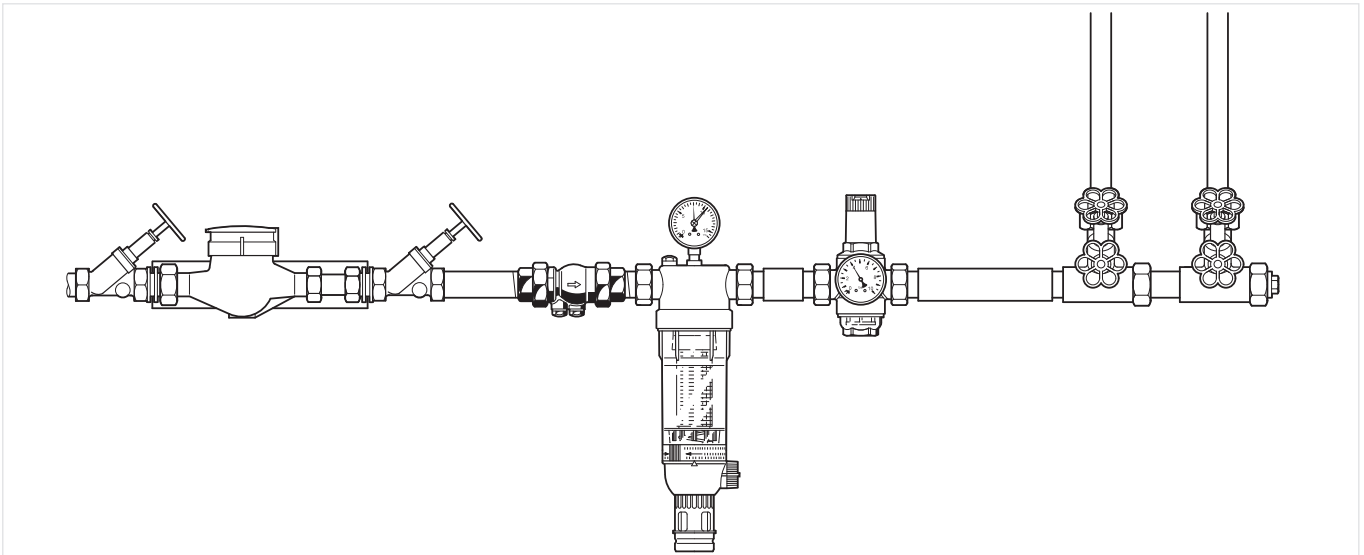

**TECHNICAL CHARACTERISTICS**

**kvs-Values**

Connection sizes:	1"	1 1/4"	1 1/2"	2"	2 1/4"	2 3/4"
kvs-value (m <sup>3</sup> /h):	4.5	9.1	17.0	28.0	38.0	60.0

**Pressure drop characteristics**

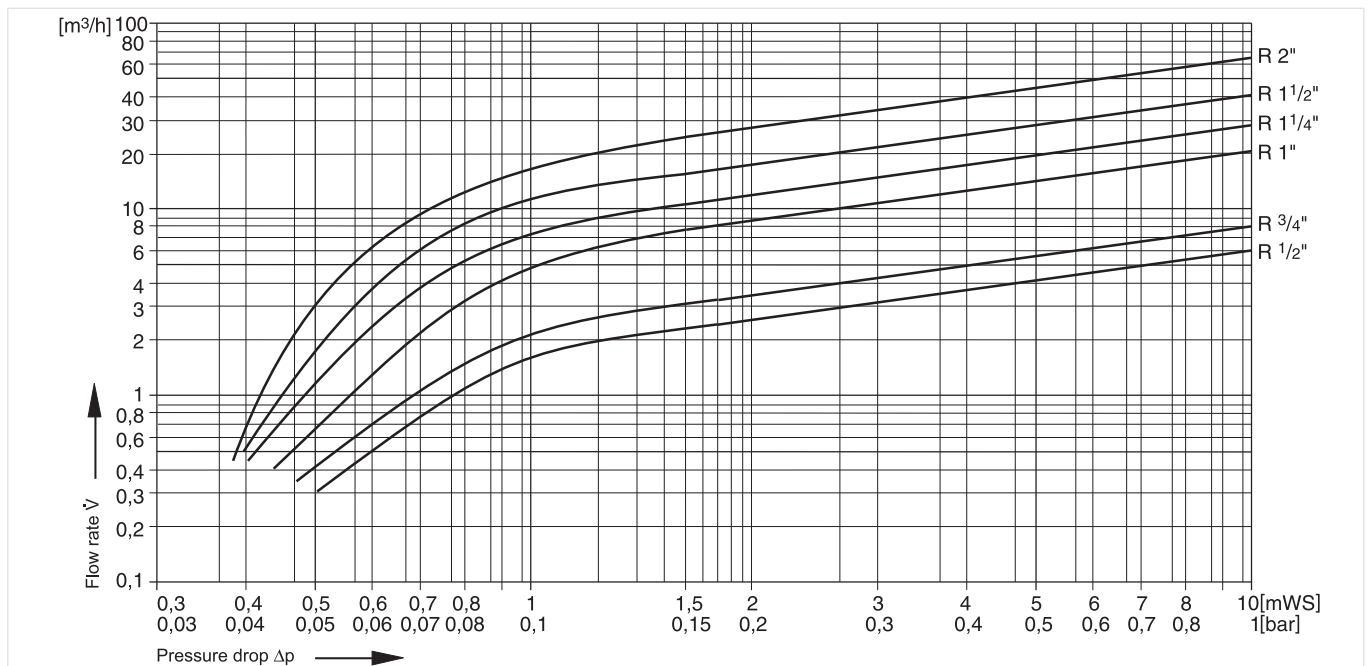
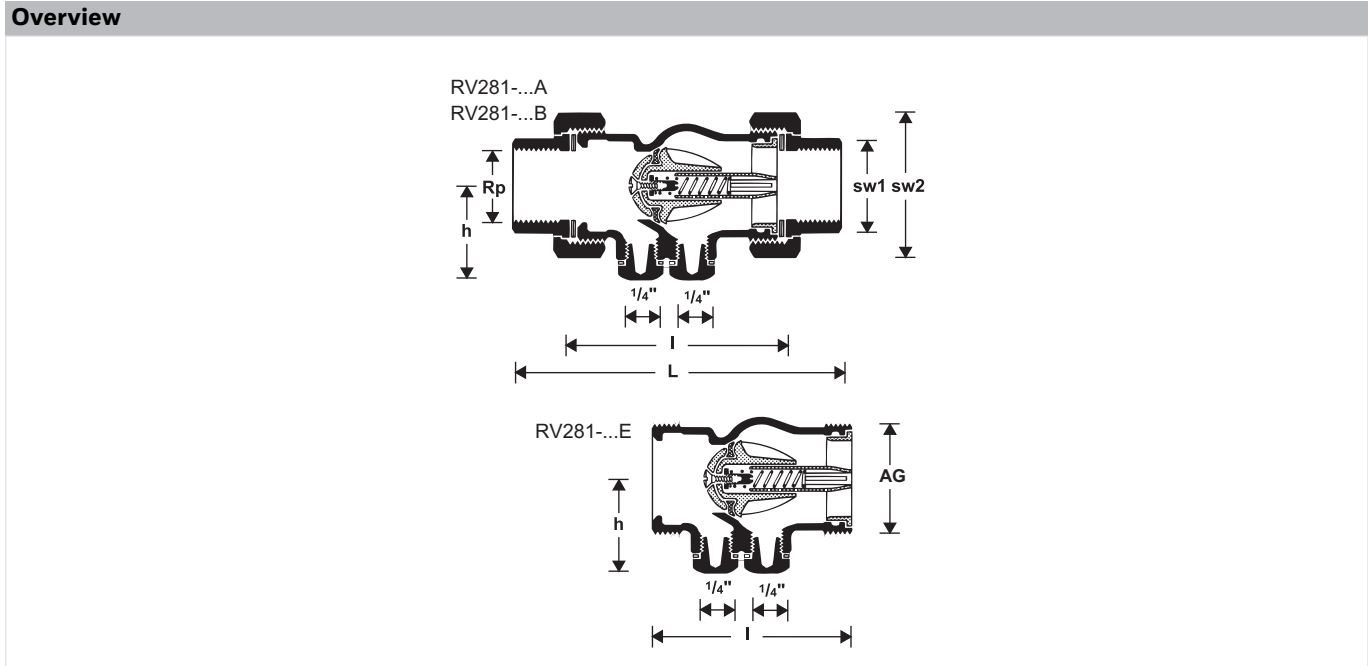

Fig. 1 Pressure drop within the valve in dependency of the flow rate and the used connection size

## DIMENSIONS



Parameter		Values						
Connection size with external threads:	AG	DN15	DN20	DN25	DN32	DN40	DN50	
		1"	1 1/4"	1 1/2"	2"	2 1/4"	2 3/4"	
		1/2"*	3/4"	1"	1 1/4"	1 1/2"	2"	
Connection size with internal threaded connection set:	Rp	15	22	28	35	42	54	
Connection size with soldering connection set:	mm	15	22	28	35	42	54	
Weight:								
Option A and B:	approx. kg	0.45	0.7	0.95	1.4	2.2	3.0	
Option E:		0.3	0.4	0.6	0.8	1.2	1.6	
Dimensions:	L	106	120	139	161	171	201	
	l	60	72	85	95	103	125	
	h	34	34	40	45	47	57	
	sw1	24	30	38	46	52	66	
	sw2	37	46	52	64	76	88	
Test and drain plug:	R	1/4" *	1/4"	1/4"	1/4"	1/4"	1/4"	
Nominal flow rate at Δp = 0.15 bar:	m <sup>3</sup> /h	2.3	3.1	7.7	10.8	15.5	25.2	
DIN/DVGW Registration No.:	NW-6310 AT 2325							
SVGW-Registration No.:	8411-1575							
lfBt designation:	P-IX 2614/I						-	-

Note: \* Test plug only

Note: All dimensions in mm unless stated otherwise.

## ORDERING INFORMATION

The following tables contain all the information you need to make an order of an item of your choice. When ordering, please always state the type, the ordering or the part number.

### Options

The valve is available in the following sizes: 1/2", 3/4", 1", 1 1/4" 1 1/2" and 2".

- standard
- not available

		RV281-...A	RV281-...B	RV281-...E
Connection type:	Internal threaded connection set	•	-	-
	Soldering connection set	-	•	-
	External thread	-	-	•

Note: ... = space holder for connection size

Note: Ordering number example for 1" and type A valve: RV281-1A

### Spare Parts

Inlet check valve RV281, from 1984 onwards

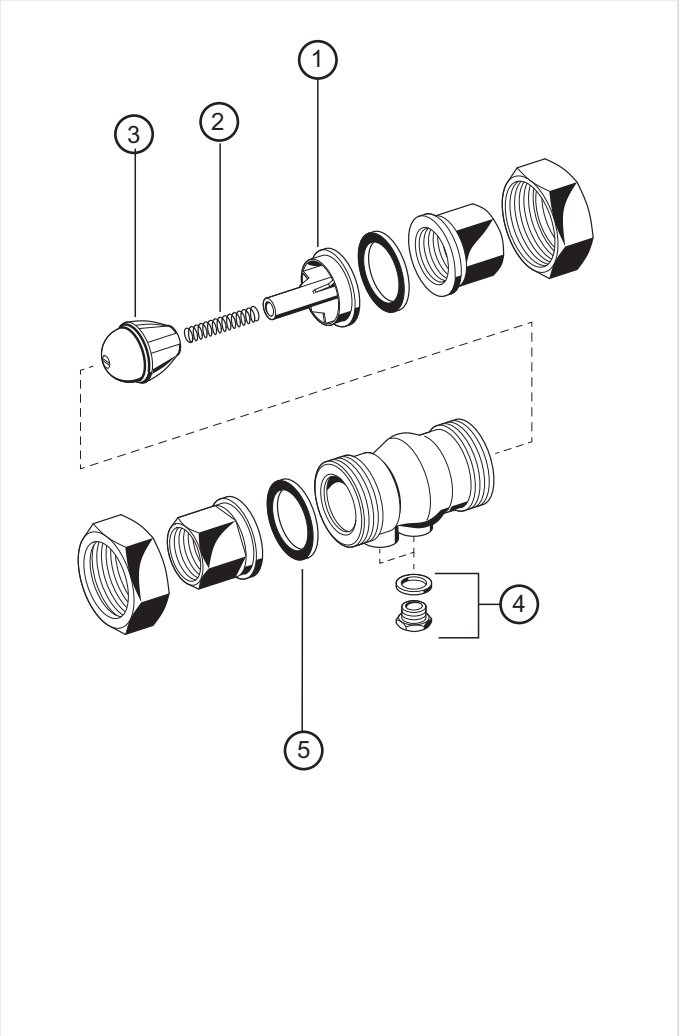
Overview	Description	Dimension	Part No.
	<b>1 Disc guide</b>		
		1/2"	5534900
		3/4"	5535100
		1"	5531500
		1 1/4"	5535300
		1 1/2"	5535500
		2"	5535700
	<b>2 Spring</b>		
		1/2"	2061400
		3/4"	2061500
		1"	2061600
		1 1/4"	2061700
		1 1/2"	2062000
		2"	2062400
	<b>3 Valve disc complete</b>		
		1/2"	0900356
		3/4"	0900357
		1"	0900358
		1 1/4"	0900359
		1 1/2"	0900360
	2"	0900361	
<b>4 Hexagon-plug with copper sealing-ring R1/4" (5 pcs.)</b>			
		S06M-1/4	
<b>5 Union seal washer</b>			
	1/2"	5351200	
	3/4"	0901445	
	1"	0901446	
	1 1/4"	0901447	
	1 1/2"	5163000	
	2"	5163100	

### Environmental & Energy Solutions

Honeywell GmbH  
 Hardhofweg  
 74821 MOSBACH  
 GERMANY  
 Phone: (49) 6261 810  
 Fax: (49) 6261 81309  
<http://ecc.emea.honeywell.com>

Manufactured for and on behalf of the  
 Environmental and Combustion Controls  
 Division of Honeywell Technologies Sàrl, Z.A.  
 La Pièce 16, 1180 Rolle, Switzerland  
 by its Authorised Representative Honeywell GmbH  
 ENOH-1202GE23 R0217  
 Subject to change  
 © 2017 Honeywell GmbH

 **AutomatikCentret**  
 Strandvejen 42 ♦ Saksild ♦ 8300 Odder  
 86 62 63 64 ♦ [www.automatikcentret.dk](http://www.automatikcentret.dk)  
[info@automatikcentret.dk](mailto:info@automatikcentret.dk)

**Honeywell**