

OpenAir™

Air damper actuators

GLB..1E







Electronic motor driven actuators for open-close, three-position and modulating control

- Nominal torque 10 Nm
- Operating voltage AC 24 V ~ / DC 24...48 V = or AC 100...240 V ~
- Mechanically adjustable span between 0...90°
- Pre-wired with 0.9 m long connection cables
- Type-specific variations with adjustable offset and span for the positioning signal
- Position indication: mechanical and electrical
- Feedback potentiometer
- Self-adaption of rotational angle range and adjustable auxiliary switches for supplementary functions

The rotary actuators are used in ventilation and air conditioning plants to regulate and shut off air dampers:

- For damper areas up to 1.6 m² (guideline, always observe damper manufacturer's data).
- Suitable for use with modulating controllers (DC 0/2...10 V), open-close or three-position controllers for air dampers or air throttles.
- We recommend a minimum pulse length of 500 ms on rotary actuators operated with 3-point control to ensure continuous and accurate operation.

Functions

| GLB.. | AC 24 V ~ / DC 24...48 V = | 141.1E / 142.1E / 146.1E | 161.1E / 163.1E / 164.1E / 166.1E |
|------------------------------------|--|---|-----------------------------------|
| | AC 100...240 V ~ | 341.1E / 346.1E | 361.1E |
| Control type | Open-close / three-position | | Modulating control (0/2...10 V) |
| Rotary direction | <p>Clockwise or counter-clockwise direction depends ...</p> <p>... on the type of control</p> <p>... on the setting of the rotary direction switch.</p> <div style="display: flex; justify-content: space-around;"> <div style="text-align: center;"> <p>CW</p>  </div> <div style="text-align: center;"> <p>CCW</p>  </div> </div> <p>With no power applied, the actuator remains in the respective position.</p> | | |
| | | <p>... on the setting of the rotary direction DIL switch</p> <div style="display: flex; justify-content: space-around;"> <div style="text-align: center;"> <p>CW</p>  </div> <div style="text-align: center;"> <p>CCW</p>  </div> </div> <p>... on the positioning signal.</p> <p>The actuator remains in the achieved position:</p> <p>... if the control signal is maintained at a constant value</p> <p>... for loss of operating voltage.</p> | |
| Position indication: Mechanical | Rotary angle position indication by using a position indicator. | | |
| Position indication: Electrical | The feedback potentiometer can be connected to external voltage to indicate the position. | Output voltage U = DC 0...10 V is generated proportional to the rotary angle. U depends on the rotary direction of the DIL switch setting. | |
| Auxiliary switch | The switching points for auxiliary switches A and B can be set independent of each other in increments of 5° within 0° to 90°. | | |
| Self-adaptation of linear span | | When self-adaptation is active, the actuator automatically determines the mechanical end positions of the linear span and maps the characteristic function (U ₀ , ΔU) to the calculated linear span. | |
| Manual adjustment | The actuator can be manually adjusted by pressing the gear train disengagement button. | | |
| Rotary angle limitation | The rotary angle of the shaft adapter can be limited mechanically with a set screw. | | |

Technical design

Components

The housing consists essentially of flame retardant, non brominated, non chlorinated glass fibre reinforced plastic.

Actuator motor / Gears

- Brushless, robust DC motors ensure reliable operation regardless of load. The damper actuators do not require an end position switch, are overload proof, and remain in place upon reaching the end stop.
- The gears are maintenance free and low noise.

Type summary

| Type | Stock no. | Control | Operating voltage | Positioning signal Y | Position indicator U = DC 0...10 V == | Feedback potentiometer 5 kΩ | Self-adaption of rotational angle range | Aux. switches | Rotary direction switch | |
|-----------|-------------|------------------------------|-----------------------------|----------------------|---------------------------------------|-----------------------------|---|---------------|-------------------------|---|
| GLB141.1E | S55499-D192 | Open-close or three-position | AC 24 V ~ / DC 24...48 V == | - | - | - | - | - | yes | |
| GLB142.1E | S55499-D193 | | | | | yes | | - | | |
| GLB146.1E | S55499-D194 | | AC 100...240 V ~ | | | - | | - | | 2 |
| GLB341.1E | S55499-D195 | | | | | - | | - | | |
| GLB346.1E | S55499-D196 | | | | | 2 | | | | |
| GLB161.1E | S55499-D270 | Modulating | AC 24 V ~ / DC 24...48 V == | DC 0/2...10 V == | yes | - | yes | - | yes | |
| GLB163.1E | S55499-D271 | | | DC 0...35 V == | yes | yes | | | | |
| GLB164.1E | S55499-D272 | | | DC 0...35 V == | yes | yes | | | | |
| GLB166.1E | S55499-D273 | | | DC 0/2...10 V == | yes | yes | | | | |
| GLB361.1E | S55499-D197 | | AC 100...240 V ~ | DC 0/2...10 V == | yes | yes | - | | | |

Nominal torque: 10 Nm (applies to all GLB..1E actuators)

Accessories

See data sheet N4698

Product documentation

| Topic | Title | Document ID |
|-----------------------|---|--------------------|
| Data sheet | Air damper actuators | A6V10636202_en--_a |
| Technical basics | Rotary damper actuators without spring return GL..E | A6V10636196_en--_a |
| Mounting instructions | GDB..1E, GLB..1E | A6V10636143_----_a |

Related documents such as environmental declarations, CE declarations, etc., can be downloaded at the following Internet address:

<http://siemens.com/bt/download>

Notes

Safety

| | |
|---|---|
|  | <p>⚠ Caution</p> |
| | <p>National safety regulations</p> <p>Failure to comply with national safety regulations may result in personal injury and property damage.</p> <ul style="list-style-type: none"> • Observe national provisions and comply with the appropriate safety regulations. • Use only properly trained technicians for mounting, commissioning, and servicing. |

Potentiometer and auxiliary switches

Potentiometer and auxiliary switches cannot be added in the field.

Installation

| | |
|---|---|
|  | <p>⚠ WARNING</p> |
| | <p>No internal line protection for supply lines to external consumers Risk of fire and injury due to short-circuits</p> <ul style="list-style-type: none"> • Adapt the line diameters as per local regulations to the rated value of the installed fuse. |

Maintenance

The actuators GLB..1E are maintenance-free.

Disposal

| | |
|---|---|
|  | <p>The device is considered an electronics device for disposal in terms of European Directive 2012/19/EU and may not be disposed of as domestic garbage.</p> <ul style="list-style-type: none"> • Dispose of the device through channels provided for this purpose. • Comply with all local and currently applicable laws and regulations.. |
|---|---|

Technical data

| Power supply (GLB1..1E) | | |
|---|-------------------------|--|
| Operating voltage (SELV/PELV) / Frequency | | AC 24 V ~ ±20 % (19.2...28.8 V ~) / 50/60 Hz DC 24...48 V = ±20 % (19.2...57.6 V =) ¹⁾ |
| Power consumption running | GLB14..1E, GLB16..1E | 2.2 VA / 1.3 W 2.5 VA / 1.5 W |
| Power consumption holding | GLB14..1E, GLB16..1E | 0.5 W 0.7 W |
| Power supply (GLB3..1E) | | |
| Operating voltage / Frequency | | AC 100...240 V ~ ±10 % (90...264 V ~) / 50/60 Hz |
| Power consumption running | GLB34..1E, GLB36..1E | 6 VA / 2 W 4 VA / 1.5 W |
| Power consumption holding | GLB34..1E, GLB36..1E | 0.9 W 0.6 W |
| Function data | | |
| Nominal torque | | 10 Nm |
| Maximum torque (blocked) | | 16 Nm |
| Minimum holding torque | | 10 Nm |
| Nominal rotary angle (with position indication) | | 90° |
| Maximum rotary angle (mechanic limitation) | | 95° ± 2° |
| Runtime for 90° rotary angle | | 150 s |
| Actuator sound power level | | 28 dB(A) |

¹⁾ C-UL: Permitted only to DC 30 V =

| Inputs | | |
|---|--|--|
| Positioning signal for GLB14..1E Operating voltage AC/DC 24 V (wires 1-6/G-Y1) AC 24 V ~ / DC 24...48 V = (wires 1-7/G-Y2) | | clockwise counterclockwise |
| Positioning signal for GLB34..1E Operating voltage (wires 4-6/N-Y1) AC 100...240 V ~ (wires 4-7/N-Y2) | | clockwise counterclockwise |
| Positioning signal for GLB16..1E Input voltage (wires 8-2/Y-G0) Current consumption Input resistance | | DC 0/2...10 V = 0.1 mA >100 k Ω |
| Max. permissible input voltage Protected against faulty wiring | | DC 35 V = limited to DC 10 V = max. AC 24 V ~ / DC 24...48 V = |
| Hysteresis for non-adjustable characteristic function for adjustable characteristic function | | 60 mV 0.6 % of ΔU |
| Adjustable characteristic function (GLB163.1E, GLB164.1E) Adjustable with 2 potentiometers: Offset U ₀ Span ΔU | | DC 0...5 V = DC 2...30 V = DC 35 V = max. AC 24 V ~ / DC 24...48 V = |
| Max. input voltage Protected against faulty wiring | | DC 35 V = max. AC 24 V ~ / DC 24...48 V = |
| Outputs | | |
| Position indicator Output signal (GLB16..1E) (wires 9-2/U-G0) Output signal (GLB36..1E) (wires 9-2/U-G-) Output voltage U Max. output current Protected against faulty wiring | | DC 0...10 V = DC ± 1 mA max. AC 24 V ~ / DC 24...48 V = |
| Aux. power supply (G- / G+) GLB36.. | | DC 24 V = ± 20 %, max. 10 mA |
| Feedback potentiometer (for GLB142.1E) Change of resistance (wires P1-P2) Load Max. sliding contact current Permissible voltage at potentiometer (SELV/PELV) Insulation resistance between potentiometer and housing | | 0...5000 Ω <0.25 W <10 mA AC 24 V ~ / DC 24...48 V = AC 500 V ~ |
| Auxiliary switches (GLB146.1E, GLB166.1E, GLB346.1E) | | |
| Switching voltage Contact rating | | AC 24...250 V ~ / DC 12...30 V = 6 A resistive, 2 A inductive, min. 10 mA @ AC 4 A resistive, 2 A inductive, min. 10 mA @ DC 30 V = 0.8 A res., 0.5 A inductive, min. 10 mA @ DC 60 V = |
| Electric strength auxiliary switch against housing Switching range for auxiliary switches / setting increments | | AC 4 kV 5°...90° / 5° |
| Factory switch setting: Switch A Switch B | | 5° 85° |
| Connection cables | | |
| Cable length | | 0.9 m |
| Cross section of prewired connection cables | | 0.75 mm ² |
| Permissible length for signal lines | | 300 m |
| Degree of protection | | |
| Insulation class AC 24 V ~ / DC 24...48 V =, feedback potentiometer AC 100...240 V ~, auxiliary switches | | As per EN 60730 III II |
| Housing protection | | IP 54 as per EN 60529 |

| Environmental conditions | |
|--|---|
| Operation Climatic conditions Mounting location Temperature extended Humidity (non-condensing) | IEC 60721-3-3 Class 3K5 interior, weather-protected -32...+55 °C <95 % r.F. |
| Transport Climatic conditions Temperature extended Humidity (non-condensing) | IEC 60721-3-2 Class 2K3 -32...+70 °C <95 % r.F. |
| Storage Climatic conditions Temperature extended Humidity (non-condensing) | IEC 60721-3-1 Class 1K3 -32...+50 °C <95 % r.F. |
| Mechanical conditions | Class 2M2 |

| Standards, directives and approvals | |
|--|--|
| Product standard | EN 60730 Part 2-14 / Particular requirements for electric actuators |
| Electromagnetic compatibility (Applications) | For use in residential, commercial, light-industrial and industrial environments |
| EU Conformity (CE) | A5W00000176 ²⁾ |
| RCM Conformity | A5W00000177 ²⁾ |
| EAC Conformity | Eurasian conformity |
| UL | UL as per UL 60730 http://ul.com/database cUL as per CSA-C22.2 No. 24-93 |

| Environmental compatibility | |
|--|--|
| The product environmental declaration A5W00026066 ²⁾ contains data on environmentally compatible product design and assessments (RoHS compliance, materials composition, packaging, environmental benefit, disposal). | |

| Dimensions | |
|---|--|
| Actuator W x H x D | see „Dimensions“, p. 9 |
| Damper shaft round round Square Min. shaft length Shaft hardness | 8...16 mm 8...10 mm (with centering element) 6...12.8 mm 20 mm <300 HV |

| Weight | |
|-------------------|---|
| Without packaging | Max. 0.49 kg, without switches Max. 0.63 kg, with switches |

²⁾ The documents can be downloaded from <http://siemens.com/bt/download>.

Internal Diagrams

GLB14..1E (open-close, three-p.)

GLB34..1E (open-close, three-p.)

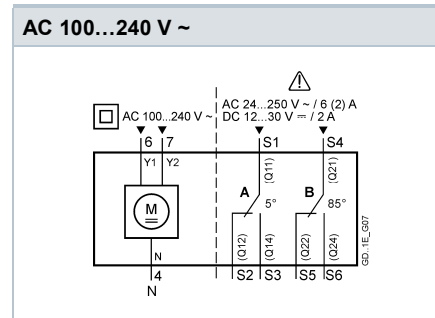
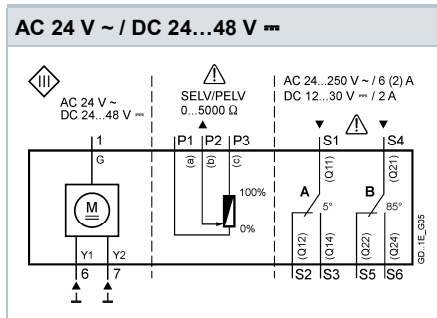

GLB16..1E (modulating, Y= DC 0/2...10 V ~)

GLB16..1E (modulating, Y= DC 0...35 V ~)

GLB361.1E (modulating control)

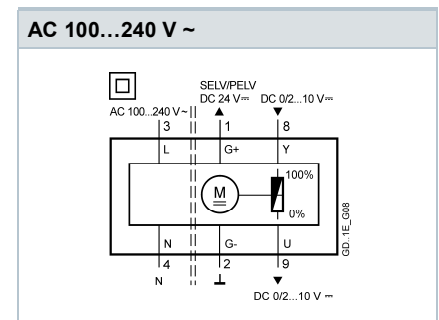
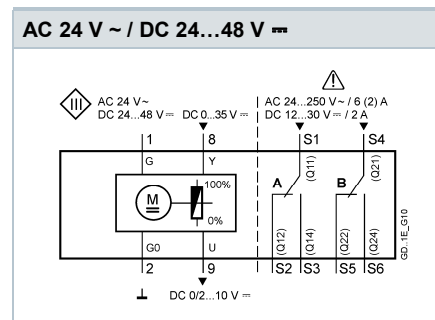
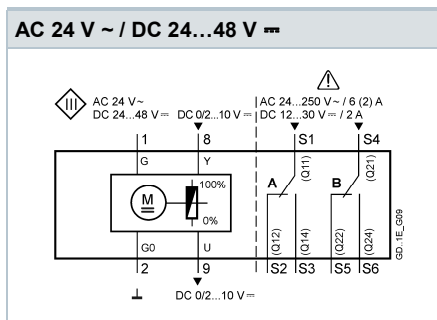

Connection diagrams

GLB1.. 1E (AC 24 V ~ / DC 24...48 V ~)

| Open-close, single wire control Single Pole Single Throw (SPST) | Open-close, two wire control Single Pole Double Throw (SPDT) | Three-position control | Modulating control |
|--|---|------------------------|--------------------|
| <p>GD..1E_A05</p> | <p>GD..1E_A06</p> | <p>GD..1E_A07</p> | <p>GD..1E_A08</p> |
| <p>GD..1E_A10</p> | <p>GD..1E_A11</p> | <p>GD..1E_A09</p> | |

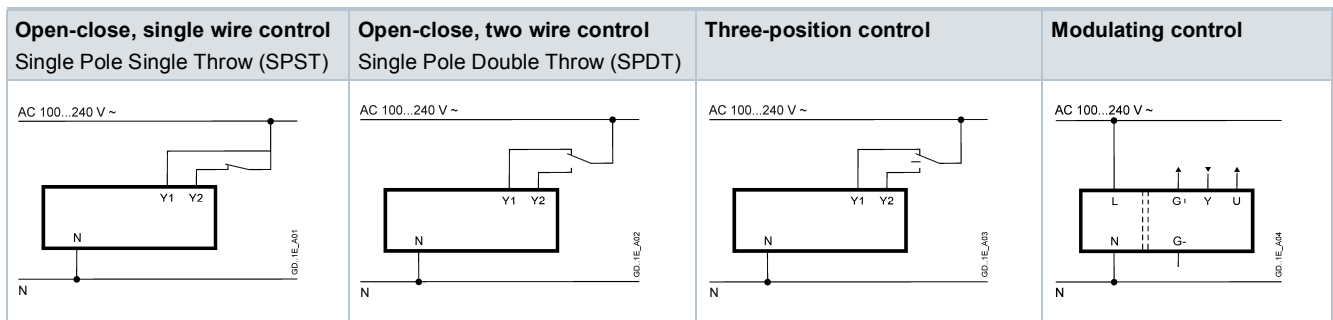

Cable labeling

| Connection | Code | No | Color | Abbreviation | Meaning |
|------------------------|------|----|------------|--------------|---|
| Actuators | G | 1 | red | RD | System potential AC 24 V ~ / DC 24...48 V = |
| AC 24 V ~ | G0 | 2 | black | BK | System neutral |
| DC 24...48 V = | Y1 | 6 | purple | VT | Positioning signal AC/DC 0 V, "clockwise" (GLB14..1E) |
| | Y2 | 7 | orange | OG | Positioning signal AC/DC 0 V, "counter-clockwise" (GLB14..1E) |
| | Y | 8 | grey | GY | Signal in (GLB16..1E) |
| | U | 9 | pink | PK | Signal out (GLB16..1E) |
| Actuators | L | 3 | brown | BR | Line AC 100...240 V ~ |
| AC 100...240 V ~ | N | 4 | light blue | BU | Neutral conductor |
| | Y1 | 6 | black | BK | Positioning signal AC 100...240 V ~, "clockwise" (GLB34..1E) |
| | Y2 | 7 | white | WH | Pos. signal AC 100...240 V ~, "counter-clockwise" (GLB34..1E) |
| | G+ | 1 | red | RD | System potential DC 24 V = (aux. power supply) (GLB361.1E) |
| | G- | 2 | black | BK | System neutral (aux. power supply) (GLB361.1E) |
| | Y | 8 | grey | GY | Signal in (GLB361.1E) |
| | U | 9 | pink | PK | Signal out (GLB361.1E) |
| Feedback potentiometer | a | P1 | white/red | WH RD | Potentiometer 0...100 % (P1-P2) |
| | b | P2 | white/blue | WH BU | Potentiometer pick-off |
| | c | P3 | white/pink | WH PK | Potentiometer 100...0 % (P3-P2) |
| Auxiliary switch | Q11 | S1 | grey/red | GY RD | Switch A input |
| | Q12 | S2 | grey/blue | GY BU | Switch A normally closed contact |
| | Q14 | S3 | grey/pink | GY PK | Switch A normally open contact |
| | Q21 | S4 | black/red | BK RD | Switch B input |
| | Q22 | S5 | black/blue | BK BU | Switch B normally closed contact |
| | Q24 | S6 | black/pink | BK PK | Switch B normally open contact |

Dimensions

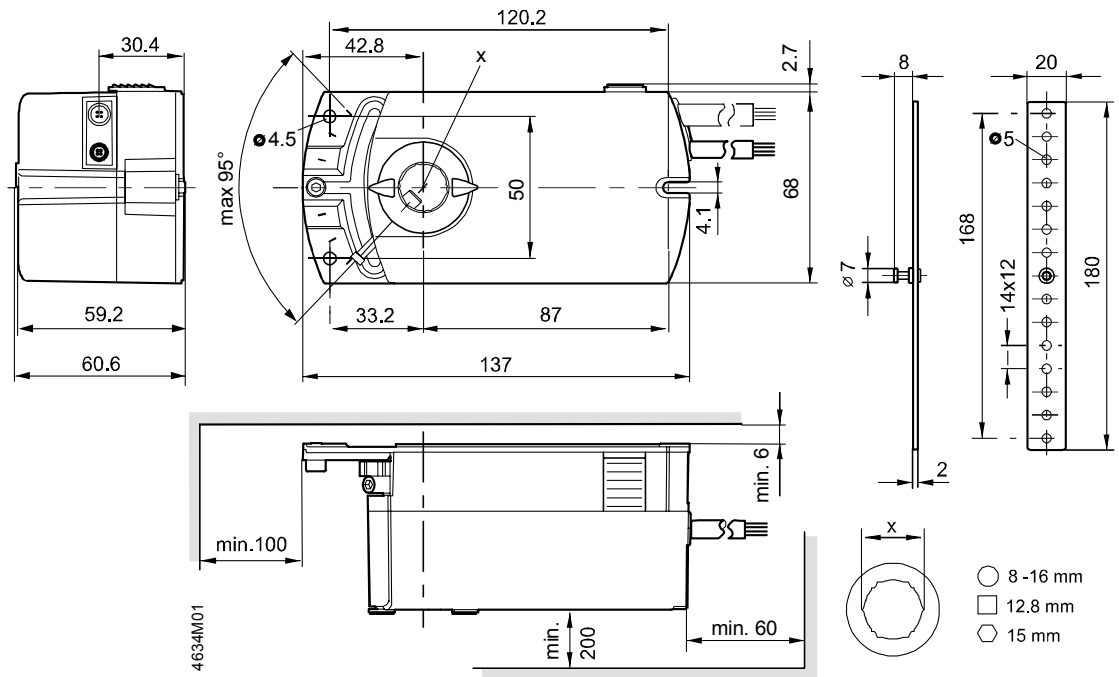

Dimensions in mm

Revision numbers

| Type | Valid from rev. no. | Type | Valid from rev. no. |
|-----------|---------------------|-----------|---------------------|
| GLB141.1E | ..B | GLB164.1E | ..B |
| GLB142.1E | ..B | GLB166.1E | ..B |
| GLB146.1E | ..B | GLB361.1E | ..B |
| GLB161.1E | ..B | GLB341.1E | ..B |
| GLB163.1E | ..B | GLB346.1E | ..B |

Issued by
Siemens Switzerland Ltd
Building Technologies Division
International Headquarters
Gubelstrasse 22
6301 Zug
Switzerland
Tel. +41 41-724 24 24
www.siemens.com/buildingtechnologies

© Siemens Switzerland Ltd, 2016
Technical specifications and availability subject to change without notice.

Document ID A6V10636202_en--_b
Issue 2016-12-14