



V2000UB

UBG type TRV Body

Radiator valve with unlimited cartridge



Strandvejen 42 • Saksild • 8300 Odder
86 62 63 64 • www.automatikcentret.dk
info@automatikcentret.dk

APPLICATION

Thermostatic radiator valve bodies (TRV bodies) are fitted on the supply or return of radiators or heat exchangers. Together with a radiator thermostat, for example the Thera-4, they control the room temperature by regulating the flow of hot water into the radiator or heat exchanger. The temperature of different rooms is controlled individually and energy is saved.

TRV bodies of this type have quiet operation and are fitted to the supply of radiators in one-pipe systems or in two-pipe systems with medium to high flow rates.

The valve insert can be replaced while the system is running and without draining using the service tool (see 'Accessories').

TRV bodies of this type are suitable for

- Honeywell Home radiator thermostats with M30 x 1.5 connection
- Certain Honeywell Home MT4 actuators
- Honeywell Home Hometronic HR80 and Roomtronic HR40 actuators

AT-CONCEPT

AT-Concept valves share the same valve housing design. The valve insert can be replaced by any other AT-Concept valve insert, i.e. BB, KV, UBG, SL, VS, FS, FV and SC.

FEATURES

- For one-pipe heating systems and two-pipe systems with medium to high flow rates
- Quiet operation
- DIN type bodies with dimensions according to EN 215, Appendix A, Series D
- NF type bodies with dimensions according to EN 215, Appendix A, Series F
- AT-Concept valve housing and insert
- Valve insert can be replaced while system is operating and without draining the system
- Valve opening spring is not in the water
- Standard M30 x 1.5 thermostat connection
- Supplied with white protection cap for clear identification



DESIGN

The thermostatic radiator valve body consists of:

- Valve housing PN10, DN10, 15, 20 or 25 with
 - internal thread connection to DIN2999 (ISO7) for threaded, copper or precision steel pipe on inlet (compression ring fittings see 'Accessories')
 - external thread connection with union-nut and radiator tailpiece on outlet (Eurocone for DN15)
 - external thread connections on inlet and outlet, without union-nut and radiator tailpiece
 - angle to DIN and straight to DIN bodies with dimensions according to EN215, Appendix A, Series D
 - angle to NF and straight to NF bodies with dimensions according to EN215, Appendix A, Series F
- Valve insert with UBG (unlimited flow) type cartridge
- Protection cap
- Union-nut and radiator tailpiece

MATERIALS

- Valve housing made of nickel-plated hot-forged brass
- Valve insert made of brass with EPDM O-rings and soft seals and stainless steel spindle
- Protection cap made of white plastic
- Union-nut and tailpiece made of nickel-plated brass

PLEASE NOTE:

- To avoid stone deposit and corrosion the composition of the medium should conform with VDI-Guideline 2035
- Additives have to be suitable for EPDM sealings
- System has to be flushed thoroughly before initial operation with all valves fully open
- Any complaints or costs resulting from non-compliance with above rules will not be accepted by Honeywell Home
- Please contact us if you should have any special requirements or needs

IDENTIFICATION

- White protection cap
- Brass insert

FUNCTION

Thermostatic radiator valves enable individual control of room temperature and thus save energy.

The TRV body is controlled by the radiator thermostat. Air from the room passing over the sensor of the radiator thermostat causes the sensor to expand when the temperature rises. The sensor acts onto the valve spindle and this causes the TRV body to close. When the temperature falls the sensor contracts and the spring-loaded valve spindle is opened. The TRV opens in proportion to the temperature of the sensor. Only the amount of water required to maintain the room temperature set on the radiator thermostat can flow into the radiator.

SPECIFICATIONS

Medium:	Heating water, water quality to VDI2035
Max. operating temperature:	130 °C (266°F)
Operating pressure:	PN10
Max. differential pressure:	100 kPa (1 bar, 14.5 psi) – 20 kPa (0.2 bar, 2.9 psi) recommended for quiet operation
k_{vs} (C_{vs})-value:	0.8 - 2.5 (0.94 - 2.93) depending on type of valve body (see „Dimensions“)
Nominal flow:	190 kg/h
Body-head connection:	M30 x 1.5
Closing dimension:	11.5 mm
Stroke:	2.5 mm

INSTALLATION EXAMPLE

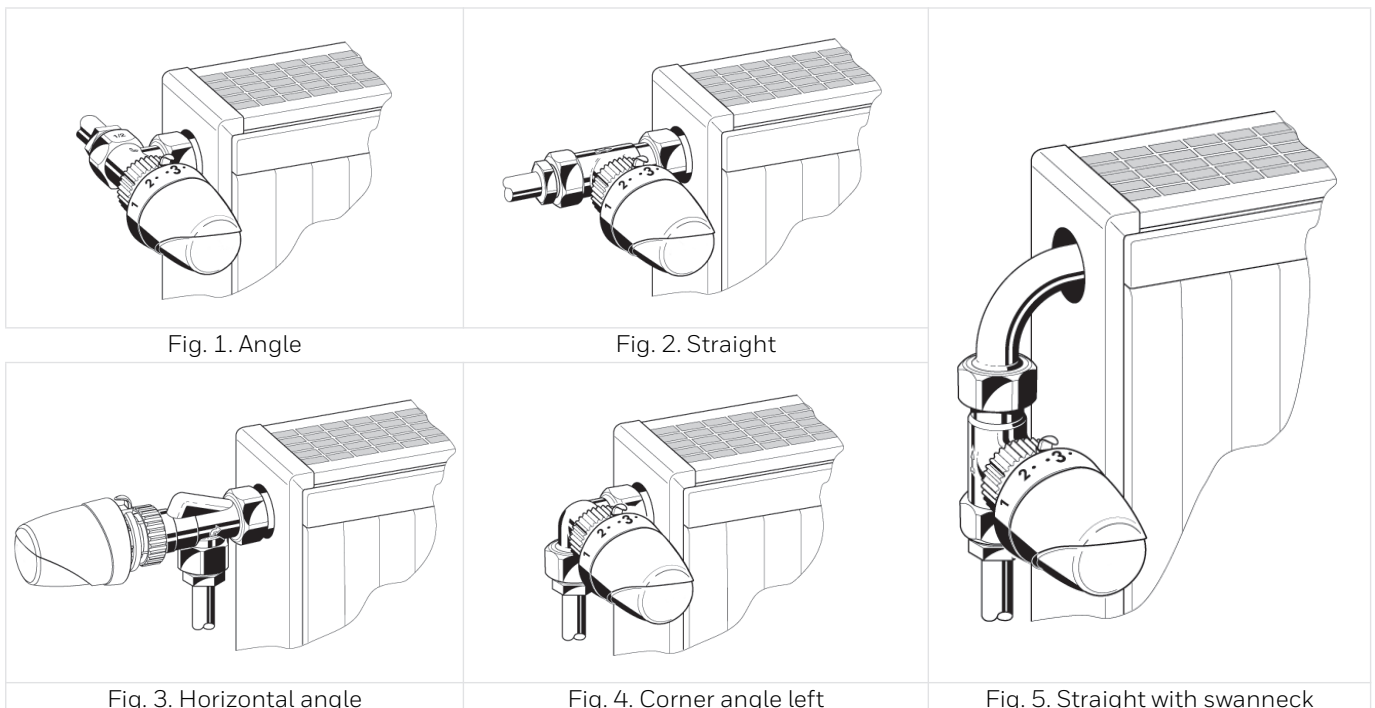

Fig. 1. Angle

Fig. 2. Straight

Fig. 3. Horizontal angle

Fig. 4. Corner angle left

Fig. 5. Straight with swanneck

DIMENSIONS AND ORDERING INFORMATION

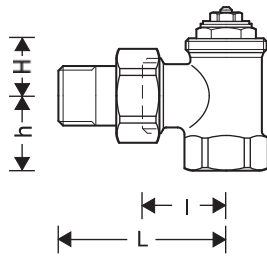

Fig. 6. Angle

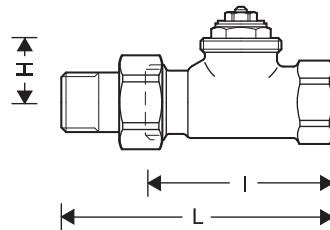

Fig. 7. Straight

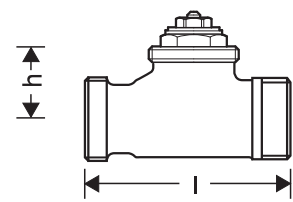

Fig. 8. Straight with external threads

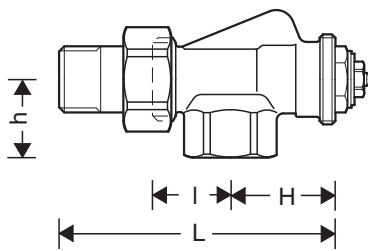

Fig. 9. Horizontal angle

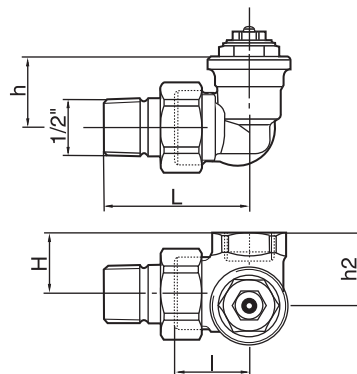

Fig. 10. Corner angle left

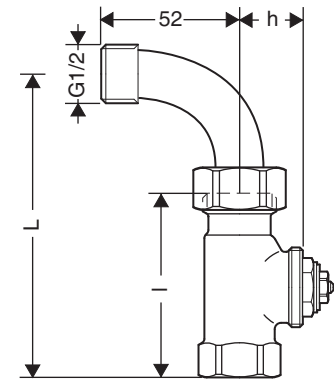

Fig. 11. Straight with swanneck

Tab. 1 Dimensions and OS-Nos (OS=Ordering System)



Body type	DN	EN 215 certified	$k_{vs}(C_{vs})$ -value	Pipe connection	l	L	h	H	h ₂	OS-No.
For the supply										
Angle to EN 215 (D) (Fig. 6)	10	•	1.70 (1.99)	Rp 3/8"	26	52	22	20	-	V2000EUB10
	15	•	1.85 (2.16)	Rp 1/2"	29	58	26	20	-	V2000EUB15
	20	•	1.95 (2.28)	Rp 3/4"	34	66	29	19	-	V2000EUB20
	25		2.20 (2.57)	Rp 1"	41.5	73	33	26	-	V2000EUB25
Straight to EN 215 (D) (Fig. 7)	10	•	1.45 (1.69)	Rp 3/8"	59	85	-	25	-	V2000DUB10
	15	•	1.85 (2.16)	Rp 1/2"	66	95	-	25	-	V2000DUB15
	20	•	1.95 (2.28)	Rp 3/4"	74	106	-	25	-	V2000DUB20
	25		2.20 (2.57)	Rp 1"	80	112.5	-	30	-	V2000DUB25
Angle to EN 215 (F) (Fig. 6)	10	•	1.80 (2.11)	Rp 3/8"	24	49	20	21	-	V2020EUB10
	15	•	1.80 (2.11)	Rp 1/2"	26	53	23	22	-	V2020EUB15
	20		1.95 (2.28)	Rp 3/4"	34	66	29	18	-	V2020EUB20
Straight to EN 215 (F) (Fig. 7)	15	•	1.10 (1.29)	Rp 1/2"	55	82	-	26	-	V2020DUB15
Horizontal angle (Fig. 9)	10		1.20 (1.40)	Rp 3/8"	24	50	22	33	-	V2000AUB10
	15		1.20 (1.40)	Rp 1/2"	26	54	26	35	-	V2000AUB15
Corner angle, radiator connection left (Fig. 10)	10		1.00 (1.17)	Rp 3/8"	24	53	26	22	26.5	V2000LUB10
	15		1.00 (1.17)	Rp 1/2"	24	53	26	26	30.5	V2000LUB15
Corner angle, radiator connection right (Fig. 10)	10		1.00 (1.17)	Rp 3/8"	24	53	26	22	26.5	V2000RUB10
	15		1.00 (1.17)	Rp 1/2"	24	53	26	26	30.5	V2000RUB15
Swanneck (Fig. 11)	15		1.60 (1.87)	Rp 1/2"	66	108	25	-	-	V2000BUB15
For the supply or return										
Straight with external threads (Fig. 8)	15		1.60 (1.87)	G 3/4" A	66	-	25	-	-	V2060DUB15

Note: All dimensions in mm unless stated otherwise.

ACCESSORIES

	Description	Dimension	Part No.
	FIG3/8CS Compression fitting for COPPER and STEEL pipe Consisting of compression nut and compression ring. For valves with internal thread. Note: Support inserts have to be used for copper or soft steel pipe with 1.0 mm wall thickness. Max. operating temperature 120 °C, max. operating pressure 10 bar.		
	3/8", DN10, 1 pcs.	10 mm	FIG3/8CS10
	3/8", DN10, 1 pcs.	12 mm	FIG3/8CS12
	1/2", DN15, 1 pcs.	10 mm	FIG1/2CS10
	1/2", DN15, 1 pcs.	12 mm	FIG1/2CS12
	1/2", DN15, 1 pcs.	14 mm	FIG1/2CS14
	1/2", DN15, 1 pcs.	15 mm	FIG1/2CS15
	1/2", DN15, 10 pcs.	15 mm	FIG1/2CS15-10
	1/2", DN15, 1 pcs.	16 mm	FIG1/2CS16
	3/4", DN20, 1 pcs.	18 mm	FIG3/4CS18
3/4", DN20, 1 pcs.	22 mm	FIG3/4CS22	
	FIG3/8CSS Compression fitting for COPPER and STEEL pipe Consisting of compression nut and compression ring and support insert. For valves with internal thread. Note: Support inserts have to be used for copper or soft steel pipe with 1.0 mm wall thickness. Max. operating temperature 120 °C, max. operating pressure 10 bar.		
	3/8", DN10	12 mm	FIG3/8CSS12
	1/2", DN15	12 mm	FIG1/2CSS12
	1/2", DN15	14 mm	FIG1/2CSS14
	1/2", DN15	15 mm	FIG1/2CSS15
	1/2", DN15	16 mm	FIG1/2CSS16
	1/2", DN15	18 mm	FIG1/2CSS18
	3/4", DN20	18 mm	FIG3/4CSS18
	FIG1/2M Compression fitting for MULTILAYER pipe. Consisting of compression nut, compression ring and support insert. For valves with internal thread. Note: Max. operating temperature 90°C, max. operating pressure 10 bar		
	1/2", DN15	16 mm	FIG1/2M16X2
	FEG3/4CS Compression fitting for COPPER and STEEL pipe. Consisting of one-piece (preassembled) nut. Soft sealing connection. For valves with external thread G ^{3/4} ". Note: Reinforcing insert for copper or soft steel pipe with 1.0 mm wall thickness not required. Max. operating temperature 90°C, max. operating pressure 10 bar.		
	G ^{3/4} ", 1 pcs.	10 mm	FEG3/4CS10
	G ^{3/4} ", 1 pcs.	12 mm	FEG3/4CS12
	G ^{3/4} ", 1 pcs.	14 mm	FEG3/4CS14
	G ^{3/4} ", 10 pcs.	14 mm	FEG3/4CS14-10
	G ^{3/4} ", 1 pcs.	15 mm	FEG3/4CS15
	G ^{3/4} ", 10 pcs.	15 mm	FEG3/4CS15-10
	G ^{3/4} ", 1 pcs.	16 mm	FEG3/4CS16
G ^{3/4} ", 1 pcs.	18 mm	FEG3/4CS18	
	FEG3/4P Compression fitting for PEX pipe. Consisting of one-piece (preassembled) nut and reinforcing insert. Soft sealing connection. For valves with external thread G ^{3/4} ". Note: Max. operating temperature 90°C, max. operating pressure 10 bar.		
	G ^{3/4} ", 1 pcs.	12 x 1.1 mm	FEG3/4P12X1.1
	G ^{3/4} ", 1 pcs.	16 x 1.5 mm	FEG3/4P16X1.5

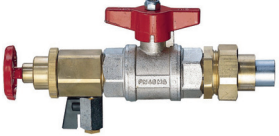
	FEG3/4PM	Compression fitting for PEX and MULTILAYER pipe. Consisting of one-piece nut with preassembled antitorion elastic compression ring and one-piece reinforcing insert. For valves with external thread G ^{3/4} ". Note: Max. operating temperature 90°C, max. operating pressure 10 bar.																											
		<table border="1"> <tbody> <tr> <td>G^{3/4}", 1 pcs.</td> <td>14 x 2 mm</td> <td>FEG3/4PM14X2</td> </tr> <tr> <td>G^{3/4}", 1 pcs.</td> <td>16 x 2 mm</td> <td>FEG3/4PM16X2</td> </tr> <tr> <td>G^{3/4}", 10 pcs.</td> <td>16 x 2 mm</td> <td>FEG3/4PM16X2-10</td> </tr> <tr> <td>G^{3/4}", 1 pcs.</td> <td>16 x 2.2 mm</td> <td>FEG3/4PM16X2.2</td> </tr> <tr> <td>G^{3/4}", 1 pcs.</td> <td>17 x 2 mm</td> <td>FEG3/4PM17X2</td> </tr> <tr> <td>G^{3/4}", 10 pcs.</td> <td>17 x 2 mm</td> <td>FEG3/4PM17X2-10</td> </tr> <tr> <td>G^{3/4}", 1 pcs.</td> <td>18 x 2 mm</td> <td>FEG3/4PM18X2</td> </tr> <tr> <td>G^{3/4}", 10 pcs.</td> <td>18 x 2 mm</td> <td>FEG3/4PM18X2-10</td> </tr> <tr> <td>G^{3/4}", 1 pcs.</td> <td>20 x 2 mm</td> <td>FEG3/4PM20X2</td> </tr> </tbody> </table>	G ^{3/4} ", 1 pcs.	14 x 2 mm	FEG3/4PM14X2	G ^{3/4} ", 1 pcs.	16 x 2 mm	FEG3/4PM16X2	G ^{3/4} ", 10 pcs.	16 x 2 mm	FEG3/4PM16X2-10	G ^{3/4} ", 1 pcs.	16 x 2.2 mm	FEG3/4PM16X2.2	G ^{3/4} ", 1 pcs.	17 x 2 mm	FEG3/4PM17X2	G ^{3/4} ", 10 pcs.	17 x 2 mm	FEG3/4PM17X2-10	G ^{3/4} ", 1 pcs.	18 x 2 mm	FEG3/4PM18X2	G ^{3/4} ", 10 pcs.	18 x 2 mm	FEG3/4PM18X2-10	G ^{3/4} ", 1 pcs.	20 x 2 mm	FEG3/4PM20X2
G ^{3/4} ", 1 pcs.	14 x 2 mm	FEG3/4PM14X2																											
G ^{3/4} ", 1 pcs.	16 x 2 mm	FEG3/4PM16X2																											
G ^{3/4} ", 10 pcs.	16 x 2 mm	FEG3/4PM16X2-10																											
G ^{3/4} ", 1 pcs.	16 x 2.2 mm	FEG3/4PM16X2.2																											
G ^{3/4} ", 1 pcs.	17 x 2 mm	FEG3/4PM17X2																											
G ^{3/4} ", 10 pcs.	17 x 2 mm	FEG3/4PM17X2-10																											
G ^{3/4} ", 1 pcs.	18 x 2 mm	FEG3/4PM18X2																											
G ^{3/4} ", 10 pcs.	18 x 2 mm	FEG3/4PM18X2-10																											
G ^{3/4} ", 1 pcs.	20 x 2 mm	FEG3/4PM20X2																											
	VA6290	Reduction piece <table border="1"> <tbody> <tr> <td>1" pipe > 1/2" valve</td> <td>VA6290A260</td> </tr> <tr> <td>1 1/4" pipe > 1/2" valve</td> <td>VA6290A280</td> </tr> <tr> <td>1" pipe > 3/4" valve</td> <td>VA6290A285</td> </tr> <tr> <td>1 1/4" pipe > 3/4" valve</td> <td>VA6290A305</td> </tr> </tbody> </table>	1" pipe > 1/2" valve	VA6290A260	1 1/4" pipe > 1/2" valve	VA6290A280	1" pipe > 3/4" valve	VA6290A285	1 1/4" pipe > 3/4" valve	VA6290A305																			
1" pipe > 1/2" valve	VA6290A260																												
1 1/4" pipe > 1/2" valve	VA6290A280																												
1" pipe > 3/4" valve	VA6290A285																												
1 1/4" pipe > 3/4" valve	VA6290A305																												
	VA5201Axxx	Radiator tailpiece with thread up to collar <table border="1"> <tbody> <tr> <td>for valves DN10 (3/8")</td> <td>VA5201A010</td> </tr> <tr> <td>for valves DN15 (1/2")</td> <td>VA5201A015</td> </tr> <tr> <td>for valves DN20 (3/4")</td> <td>VA5201A020</td> </tr> </tbody> </table>	for valves DN10 (3/8")	VA5201A010	for valves DN15 (1/2")	VA5201A015	for valves DN20 (3/4")	VA5201A020																					
for valves DN10 (3/8")	VA5201A010																												
for valves DN15 (1/2")	VA5201A015																												
for valves DN20 (3/4")	VA5201A020																												
	VA5204Bxxx	Extended radiator tailpiece, nickel-plated, to be shortened as required <table border="1"> <tbody> <tr> <td>3/8" x 70 mm (for DN10) thread approx. 50 mm</td> <td>VA5204B010</td> </tr> <tr> <td>1/2" x 76 mm (for DN15) thread approx. 65 mm</td> <td>VA5204B015</td> </tr> <tr> <td>3/4" x 70 mm (for DN20) thread approx. 60 mm</td> <td>VA5204B020</td> </tr> </tbody> </table>	3/8" x 70 mm (for DN10) thread approx. 50 mm	VA5204B010	1/2" x 76 mm (for DN15) thread approx. 65 mm	VA5204B015	3/4" x 70 mm (for DN20) thread approx. 60 mm	VA5204B020																					
3/8" x 70 mm (for DN10) thread approx. 50 mm	VA5204B010																												
1/2" x 76 mm (for DN15) thread approx. 65 mm	VA5204B015																												
3/4" x 70 mm (for DN20) thread approx. 60 mm	VA5204B020																												
	VA2200Dxxx	Manual handwheel cap Presettable, with integrated locking device VA2200D001																											
	VA2202Axxx	Pressure cap – for shutting off valves on radiator outlet <table border="1"> <tbody> <tr> <td>for valves DN10 (3/8")</td> <td>VA2202A010</td> </tr> <tr> <td>for valves DN15 (1/2")</td> <td>VA2202A015</td> </tr> <tr> <td>for valves DN20 (3/4")</td> <td>VA2202A020</td> </tr> </tbody> </table>	for valves DN10 (3/8")	VA2202A010	for valves DN15 (1/2")	VA2202A015	for valves DN20 (3/4")	VA2202A020																					
for valves DN10 (3/8")	VA2202A010																												
for valves DN15 (1/2")	VA2202A015																												
for valves DN20 (3/4")	VA2202A020																												
	VA5090	Sealing ring for pressure cap <table border="1"> <tbody> <tr> <td>for valves DN10 (3/8")</td> <td>VA5090A010</td> </tr> <tr> <td>for valves DN15 (1/2")</td> <td>VA5090A015</td> </tr> <tr> <td>for valves DN20 (3/4")</td> <td>VA5090A020</td> </tr> </tbody> </table>	for valves DN10 (3/8")	VA5090A010	for valves DN15 (1/2")	VA5090A015	for valves DN20 (3/4")	VA5090A020																					
for valves DN10 (3/8")	VA5090A010																												
for valves DN15 (1/2")	VA5090A015																												
for valves DN20 (3/4")	VA5090A020																												

	VA8200A	Service tool to replace valve insert	
			for all sizes VA8200A001
	VS1200UB	Replacement valve insert	
		UBG type	VS1200UB01

FLOW DIAGRAM

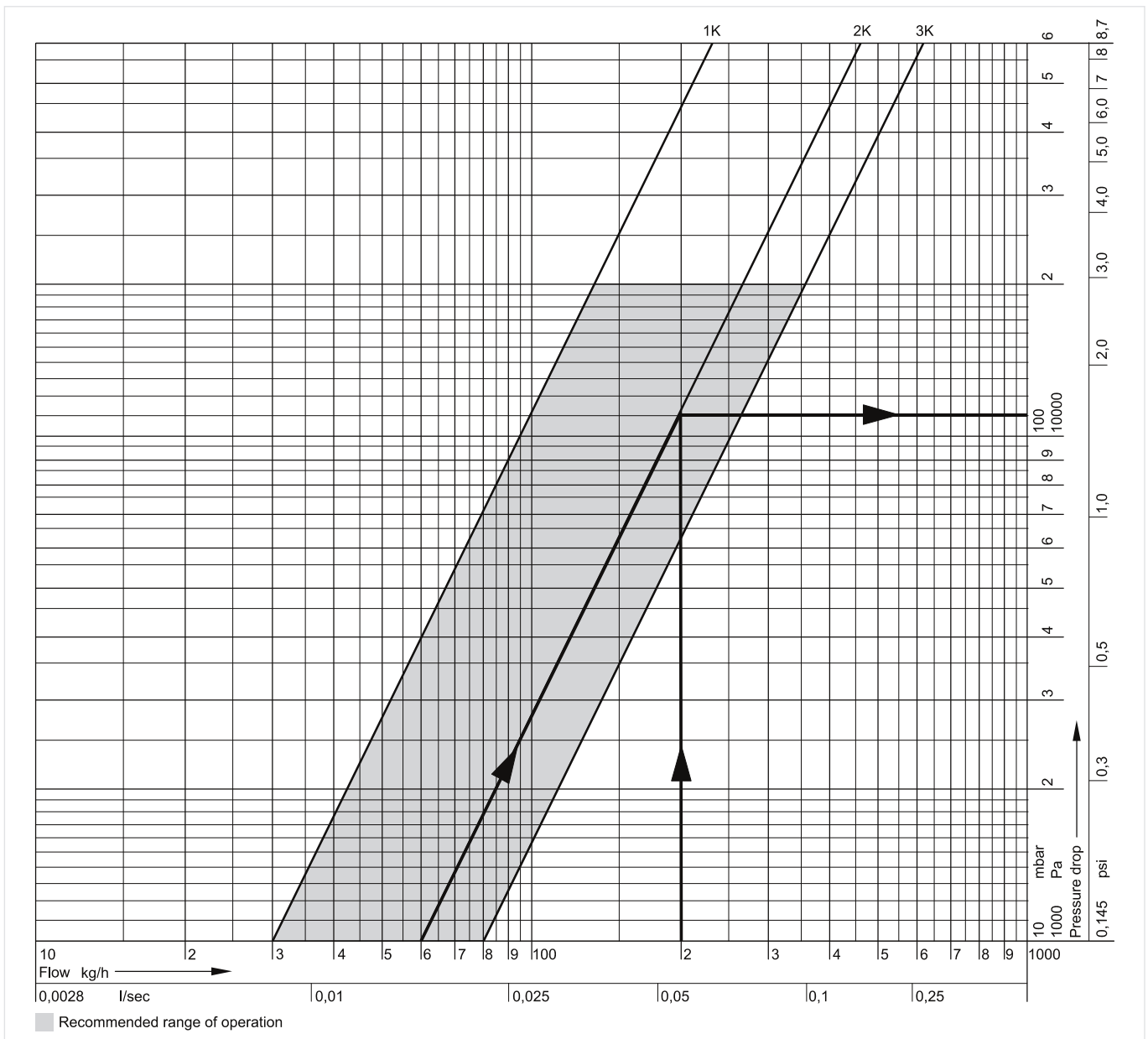

P-Band	1 K	2 K	3 K
k_v-value	0.3	0.6	0.8
cv-value	0.35	0.70	0.94

Design example

Given: Flow rate 200 kg/h
 Required: Pressure loss (Δp) with a P-band of 2K
 Solution: The required pressure loss is found at the intersection of the flow line with the line for the chosen valve performance P=2K
 Result: $\Delta p = 110 \text{ mbar} = 11\,000 \text{ Pa}$

Note: k_{vs} (cv)-values: see Table k_{vs} -(cv)-values

KVS (CV)-VALUES

	DN10 (3/8")	DN15 (1/2")	DN20 (3/4")	DN25 (1")
Angle to EN215 (D)	1.70 (1.99)	1.85 (2.16)	1.95 (2.28)	2.20 (2.57)
Straight to EN215 (D)	1.70 (1.99)	1.85 (2.16)	1.95 (2.28)	2.20 (2.57)
Angle to EN215 (F)	1.80 (2.11)	1.80 (2.11)	1.95 (2.28)	-
Straight to EN215 (F)	0.80 (0.94)	1.10 (1.29)	1.95 (2.28)	-
Horizontal angle	1.20 (1.40)	1.20 (1.40)	-	-
Corner angle	1.00 (1.17)	1.00 (1.17)	-	-
Swanneck	-	1.60 (1.87)	-	-
Straight with external threads	-	1.60 (1.87)	-	-

For more information

homecomfort.resideo.com/europe



Ademco 1 GmbH
 Hardhofweg 40
 74821 MOSBACH
 GERMANY
 Phone: +49 6261 810
 Fax: +49 6261 81309

Manufactured for and on behalf of the
 Pittway Sàrl, La Pièce 4, 1180 Rolle, Switzerland
 by its Authorised Representative Ademco 1 GmbH
 EN0H-2101GE25 R0520

Subject to change

© 2020 Pittway Sàrl. All rights reserved.

This document contains proprietary information of Pittway Sàrl and its affiliated companies and is protected by copyright and other international laws. Reproduction or improper use without specific written authorisation of Pittway Sàrl is strictly forbidden. The Honeywell Home trademark is used under license from Honeywell International Inc.

Honeywell Home