

T4 Thermostat

Programmable Thermostat info@automatikcentret.dk

EN

Quick Start Installation Guide

Compatible with 24-230V on/off appliances such as gas boilers, combi-boilers and zone valves.

Not compatible with 230V electric heating.



Installation in 3 steps...

1 Wire the Thermostat

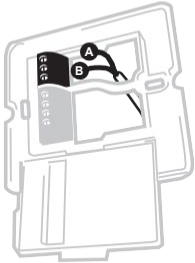

2 Power Up and Test

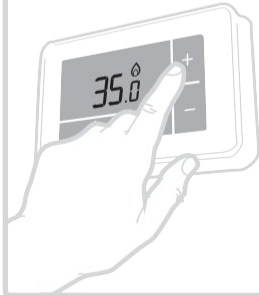

3 Configure the System

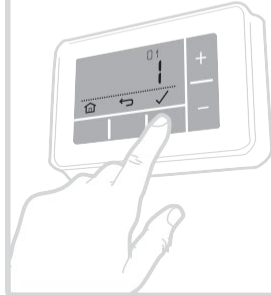

Must be installed by a competent person.

To ensure your safety make sure the mains power is switched OFF before accessing wiring.

32318056-001 B

1 Wire the Thermostat

Find a suitable wall location away from draughts, direct sunlight or other heat sources, and where cables can be run from the boiler to the thermostat.

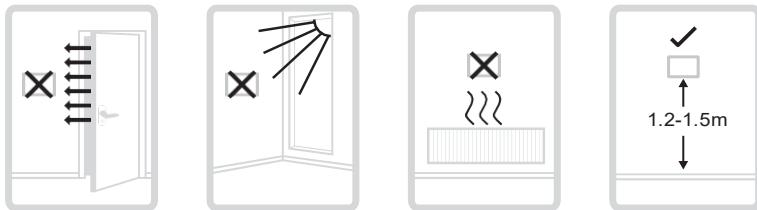

A) Separate the wallplate from the thermostat, and using a screwdriver open the wallplate terminal cover to connect wires.

B) Connect wires according to wiring diagrams and clip the cover closed.

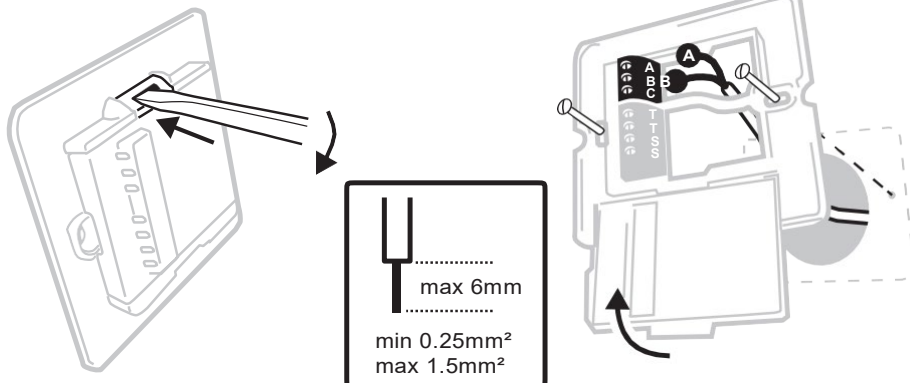

Basic 230V Boiler

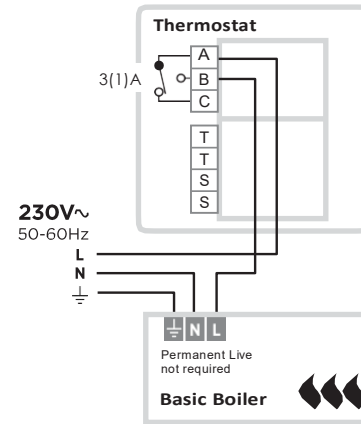

Combi-Boiler

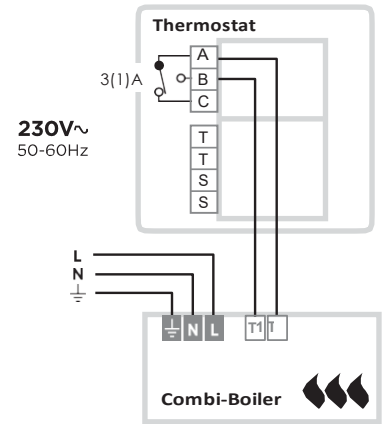

2-Port Zone Valve

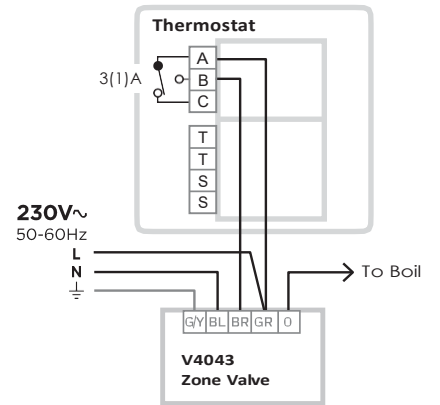

To prevent a short circuit from a loose wire -

- **When using multi-core cables:** Only remove enough outer insulation to allow secure fixing of the cores into the terminal block.
- **When using single core cables:** Secure them together with a cable tie as close as possible to the terminal block.

2 Power Up and Test

A) Power Up the Thermostat
Remove the battery tab and clip the thermostat onto the wallplate.



B) Power Up the Heating System
and do a quick functional test on the thermostat to check that it switches the boiler.

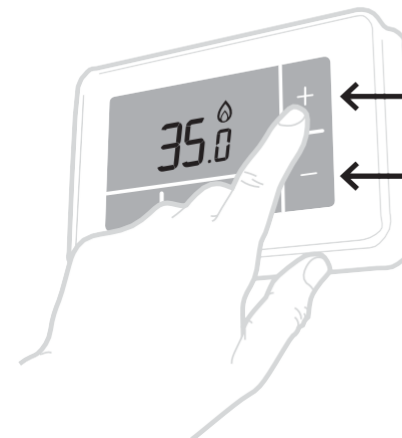

Press the **+** button to increase the temperature to maximum and **check the boiler switches on** – The heat demand icon  on the thermostat should be **on**.

Now press the **-** button to decrease the temperature to minimum and **check the boiler switches off** – The heat demand icon  on the thermostat should also go **off**.

3 Configure the System

Specific settings for the thermostat and heating system can be configured in the advanced menu.

Press and hold and then buttons together until the display changes (approx. **3 seconds**).

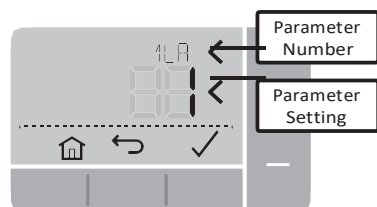

A) Press and buttons to navigate through the parameter list

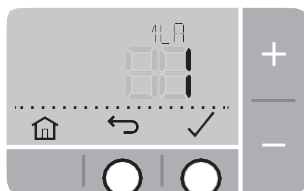

B) Press and buttons to change a parameter

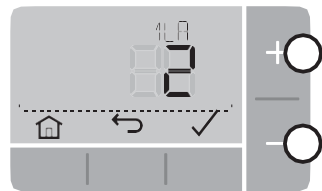

C) Press button to save the change (or press to cancel the change)

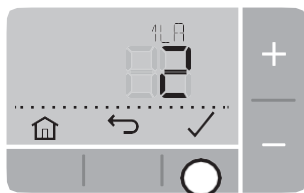

D) Press button to exit advanced menu and save any changes



Adding a Remote Temperature Sensor

A remote temperature sensor can be added if the Thermostat needs to be installed in a different location from where the room temperature needs to be measured.

If a remote sensor is added parameter N° 8 Ss needs to be changed to '1'.

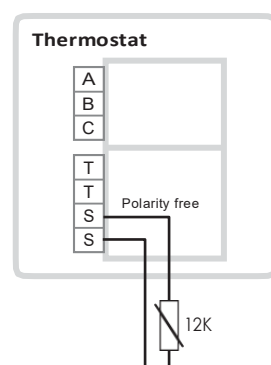

Parameters

N°	Description	Settings (default in bold)
1 LA	Language	1 = EN , 2 = NL, 3 = FR, 4 = DE, 5 = ES
2 CR	Heating Cycle Rate (cph)	3 (oil boiler / thermal actuator) 6 (gas or combi boiler / zone valve) 9 12
3 OT	Minimum on time	1 - 5 (mins) (set to 4 mins for oil boiler)
4 LL	Lower Temperature Limit	5 - 21 (°C)
5 UL	Upper Temperature Limit	21 - 35 (°C)
6 SO	Schedule options	1 = 7 day (different schedule each day of the week) 2 = 5 + 2 day (weekday + weekend schedule) 3 = 1 day (same schedule every day)
7 NP	Number of periods per day	4 or 6
8 SS	Wired Remote Sensor	0 = No Remote Sensor , 1 = Wired Remote Sensor
9 LC	Fail Safe mode	0 = Boiler off , 1 = Boiler 20% on / 80% off
10 BL	Backlight	0 = Off, 1 = On (only on demand)
11 CL	Clock Format	0 = 24 hr , 1 = AM/PM
12 DS	Daylight Saving time change	0 = Off, 1 = Auto
13 TO	Temperature Display Offset	+/-1.5°C
15 SD	Restore Schedule Defaults	0 , 1 = reset
16 FS	Restore Factory Settings	0 , 1 = reset

Troubleshooting

What's happening?	What it could mean...	How to fix it...
Thermostat display is blank	Batteries exhausted, installed incorrectly or tab hasn't been removed	Unclip thermostat from wall and check battery installation - replace batteries if necessary
Display =	Battery power critically low	Unclip thermostat from wall and replace batteries immediately
Display =	Faulty temperature sensor	Replace thermostat or check wiring to remote temperature sensor if fitted
Thermostat shows heat demand but boiler doesn't respond	Boiler (water) already at temperature Faulty wiring connection	Normal behaviour - wait for water temperature to drop Check wiring at thermostat and boiler terminals

Conforms to protection requirements of the following directives:
EMC: 2014/30/EU and LVD: 2014/35/EU

ErP: Class IV (+2%), (EU) 811/2013

WEEE Directive 2012/19/EC - Waste Electrical and Electronic Equipment directive
At the end of the product life dispose of the packaging and product in a corresponding recycling centre. Do not dispose of the unit with the usual domestic refuse. Do not burn the product.



resideo
www.resideo.com

Ademco 1 GmbH
Hardhofweg 40
74821 Mosbach
Phone: +49 1801 466 388
info.de@resideo.com
homecomfort.resideo.com

©2020 Resideo Technologies, Inc.
All rights reserved The Honeywell Home trademark is used under license from Honeywell International Inc. This product is manufactured by Resideo Technologies, Inc and its affiliates.