



APPLICATION

The C4065/C6065 differential air pressure switch for forced flue combustion type burner system functions as a (combustion) airflow supervision with a safe start interlock. The C4065/C6065 differential pressure switch is designed to be used on air or combustion products. The C6065AH and C6065FH with enhanced accuracy are according the requirements of high efficiency appliances.

Note:

Read the installation, mounting and wiring instructions before use of the pressure switch

Contents

General	Page
Description	2
Features	4
Assembled shape	5
Technical	
Specifications and characteristics	6
Mounting position	7
Dimensional drawing	9
Installation	
Installation	10
Mounting	11
Wiring	12
Various	
Quality assurance statement	13
Approvals	14
Ordering information	15
Accessories	16

DESCRIPTION

Usually the C4065/6065A functions as a (combustion) airflow supervisor with a safe start interlock. The standard Air Pressure Switch orientation is with the diaphragm in vertical position ($\pm 10^\circ$). For the above reason it is important to determine the ON/OFF point of the burner.

How to determine ON/OFF point

The ON/OFF point value should be determined by measuring the pressure differential where the air pressure switch will be connected. The setting of the ON/OFF point must be determined by measuring the pressure differential on the position where the pressure switch is to be installed.

NOTE: It is important to start the test with a cold appliance and under worst condition (exhaust must have minimal 3 meter length)

How to choose the set point

Measuring pressure differential versus time, following characteristics will appear:

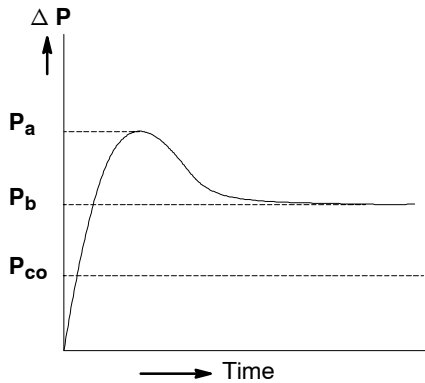

Meaning of point **Pa**, **Pb**, **Pco** is the following:
Pa: Maximum pressure differential with a cold appliance.
Pb: Maximum pressure differential in a normal working appliance.
Pco: CO point, this means that the appliance starts to produce more CO than allowed.

NOTE: Make sure that the burner is switched off before the CO-point is reached, using the methods prescribed in the applicable standards.

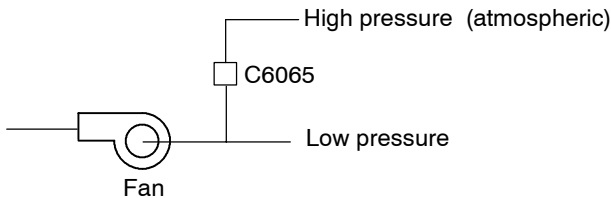

Fig. 1. Air path circuit

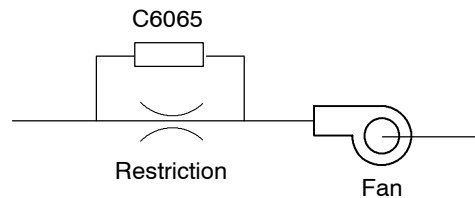

Fig. 2. Air path circuit

Specification set point of C6065A, C6065F, C6065AH and C6065FH (when setting on OFF-point, see also fig. 3. page 3)

- Determine **Pco** (CO point) as described:

$$\text{Min. } P_{\text{OFF}} = P_{\text{co}}$$
- Calculate nominal OFF-point:

$$P_{\text{OFF}} = P_{\text{co}} + \text{tolerances on setting point}$$

Example: 9 Pa for C6065A, F
 6 Pa for C6065AH, FH
- Nominal ON-point is:

$$P_{\text{ON}} = P_{\text{OFF}} + \text{differential}$$

Differential depends on product and micro switch (see page 6 and 8)
- Calculate max. **P(ON)**:

$$\text{Max. } P_{\text{ON}} = P_{\text{ON}} + \sqrt{(\text{Tol. diff})^2 + (\text{Tol. setting})^2}$$

(see table 2. page 6)
- Check that the fan can reach this pressure differential under **all** circumstances specified in the Standards

NOTE: When setting on ON-point, the min (OFF-point) is calculated in the same way and it must be higher than **Pco**.

Application notes

- Considerations should be given to the following guidelines in applying the C6065 air pressure switch:
- Sensing pressure must always be above the operating set point, even if the pressure drops after burner ignition.
 - When abnormal combustion would result from a reduced air flow rate (pressure drop), the appliance must either not start up, or shut down if already in operation.
 - Appliance must stop if the air inlet or flue outlet becomes restricted, resulting in a hazardous combustion situation. The air path circuit shown in figures 1., and 2. is suitable.

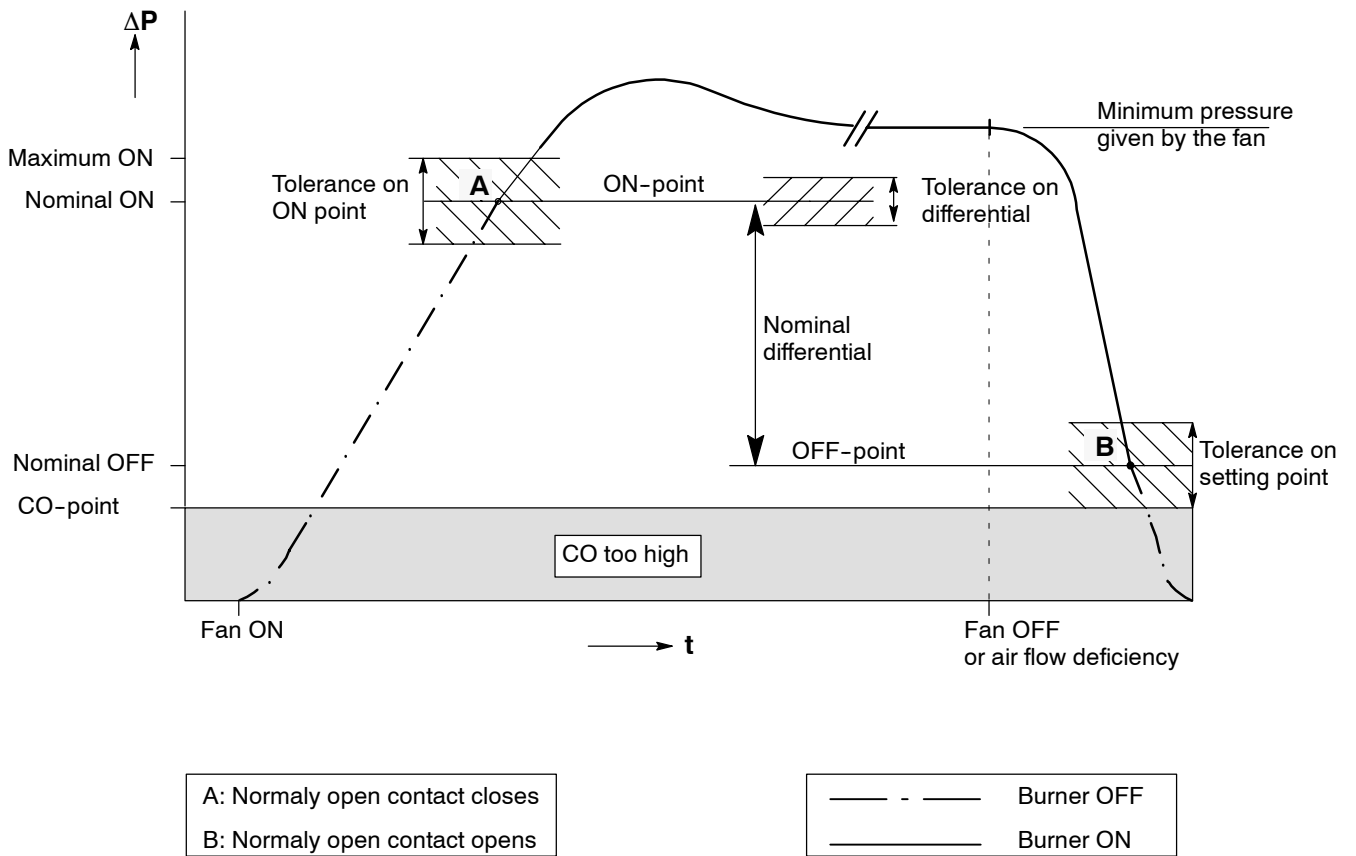

Fig. 3. How to choose the set point

Table 1. Pressure table conversion

	1 Pa =	1 mbar =	1 mm H ₂ O =	1 mm Hg =	1 psi =
in Pa	1	100	9.8	133.3	6895
in mbar	0.01	1	9.8x10 ⁻²	1.333	68.95
in mm H₂O	0.102	10.2	1	13.6	704
in mm Hg	7.5x10 ⁻³	0.75	7.35x10 ⁻²	1	51.72
in psi	1.45x10 ⁻⁴	1.45x10 ⁻²	1.42x10 ⁻³	1.93x10 ⁻²	1

FEATURES

- Suitable for positive or negative pressure applications.
- Senses positive or negative differences from atmospheric pressure or in differential pressure up to 400 Pa. Optional 900 Pa.
- C6065 series can be used up to 90 °C
- Can be used with air or combustion products.
- Pressure set-point is factory set. Optional: free adjustable.
- Enhanced accuracy version to meet the tight tolerances of high efficiency applications
- Diaphragm responds to pressure changes as low as 25 Pa.
- Equipped with 6.35 (optional 4.8 mm) male quick connect terminals.
- Connection parts accept standard 5 mm rubber or plastic tubing.

ASSEMBLED SHAPE

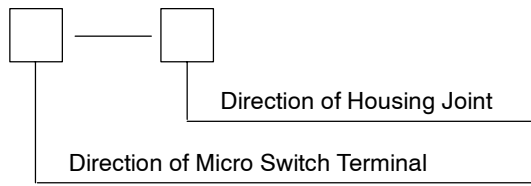

C: Center (top)
 L: Left
 R: Right

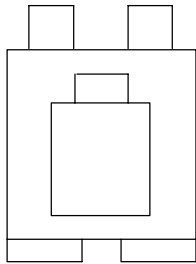

C-C

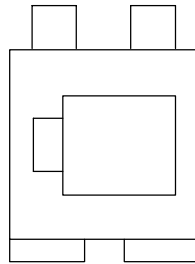

L-C

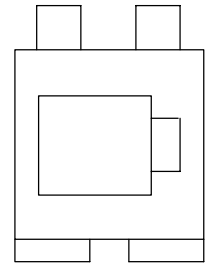

R-C

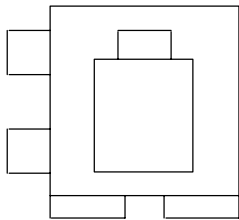

C-L

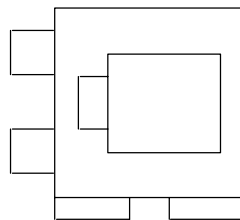

L-L

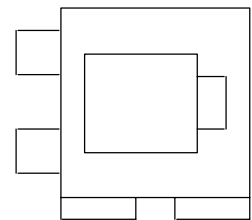

R-L

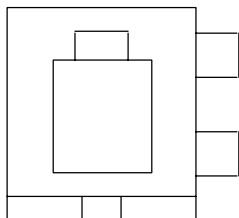

C-R

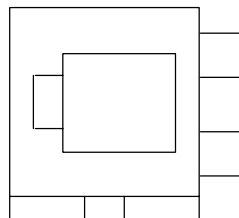

L-R

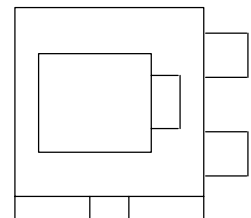

R-R

SPECIFICATIONS AND CHARACTERISTICS

All specifications and characteristics in the product handbook refer to vertical installation. Sometimes horizontal installation is required. In that case, the operating set point shifts as indicated in fig. 4.

Mounting

Within 10° of the vertical

Material

Diaphragm: silicon

Switch mounting plate: zinc coated steel

Housing: PET

Terminals

6.35 mm quick connect (AMP 250)

Ambient temperature (operational temperature)

-40 ... 90 °C (BSI/CE and KEMA approved)

(Products type A/AH manufactured before week 9608:

-10 ... 70 °C)

Relative humidity

5 ... 90% RH at 40 °C non condensing.

Table 2. Setting range and accuracy

Pressure range (Pa)	Type of model	O.S. number	Setting (OFF) accuracy ^(a) ^(b)	Differential in Pa ^(b) (with V-5610R-041)	Calculated (ON) accuracy ^(a) ^(b)
40 ... 100 (Low range)	Standard	C6065A/F	± 9 Pa	12 ± 8 ^(c)	± 12 Pa
	Enhanced	C6065AH/FH	± 6 Pa	12 ± 8 ^(c)	± 10 Pa
100 ... 200 (Middle range)	Standard	C6065F	± 13 Pa	13 ± 8	± 15 Pa
	Enhanced	C6065FH	± 10 Pa	13 ± 8	± 13 Pa
100 ... 400 (High range)	Standard	C6065A/F	± 18 Pa	23 ± 12	± 22 Pa
	Enhanced	C6065AH/FH	± 15 Pa	23 ± 12	± 20 Pa

(a) The accuracy is defined under "3σ" and with the following factors:

- A: Adjustment error
- B: Repeatability
- C: Package drop test

(b) Differential and accuracy depend of the micro switch used. The V-5106R-041 is the standard micro switch (For more details see page 8)

(c) 15 Pa differential option (also for products manufactured before week 9608)

NOTE: With the C4065/6065 in horizontal position and micro switch up, the off-point can not be set lower than 23 Pa.
When specifying the required setting also the actual mounting orientation should be stated.

NOTE: Operating point is factory set under a tight quality assurance program. To maintain specified performance, the sealed adjustment screws on the back of the device must not be turned.

MOUNTING POSITION

Horizontal mounting

When the air pressure switch is to be mounted with the diaphragm horizontal, it is critical to state it. The weight of the membrane will move up or down the setting point, compared with the vertical mounting. See fig. 4. for the shift.

When the product is used horizontally, in the particular case when the micro switch is in upper position, the setting tolerances are increased as described by table 3.

Position of micro switch	"ON" point Pa	"OFF" point Pa
Upper 	- 12	- 12
Lower 	+ 11	+ 11

Fig. 4. Shift set point

Table 3.

Tolerances to be added to accuracy of table 2.page 6			
	Low range 40 ... 100 Pa	Middle range 100 ... 200 Pa	High range 100 ... 400 Pa
	± 2 Pa	± 2 Pa	± 3 Pa

Free adjustable models without pre-setting (see table 4.)

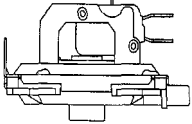
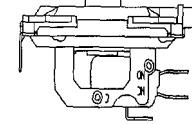
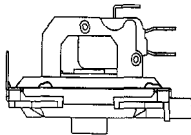
- No sealant on the adjustment screw.

- Standard assembled shape C - C
- Standard micro switch V-5610R-041

Table 4. Specifications free adjustable models*

Pressure range type	O.S. number	Adjustable "ON" point (Pa)	Differential (Pa)	Achievable setting accuracy (Pa)		Max. operating pressure
				Standard	Enhanced	
Low range	C6065F 1175	39 ~ 98	12 ± 8	± 9	± 6	600 Pa
High range	C6065F 1183	98 ~ 390	23 ± 12	± 18	± 15	

* For the middle range model, please contact your Honeywell engineer

Table 5. Electrical rating, contact resistance and pressure setting

Model of used micro switch	Contact type/terminal size	Contact resistance (initial)	Electrical rating (resistive)	Minimum electrical rating	Maximum pressure (Pa)	ON point setting range (Pa)											
						40 ... 100		100 ... 200		100 ... 400		100 ... 300		300 ... 900			
						S.A.*	Diff.	S.A.*	Diff.	S.A.*	Diff.	S.A.*	Diff.	S.A.*	Diff.		
V-5610D-011	Silver SPDT/ 4.8 mm	100 mΩ max	250 Vac 5 A	125 Vac 24 Vdc 50 mA	1000	±9	30±20	-	-	-	-	±20	40±30	±70	60±30		
V-5610R-041	Silver SPDT/ 6.35 mm	300 mΩ max	250 Vac 24 Vdc 1,5 A	125 Vac 24 Vdc 0,2 A	600	±9	12±8**	±13	13±8	±18	23±12	-	-	N.A.	N.A.		
V-5610R-044	Silver SPDT/ 6.35 mm	100 mΩ max	250 Vac 5 A	125 Vac 24 Vdc 50 mA	1000	±9	30±20	-	-	-	-	±20	40±30	±70	60±30		
V-5610RK	Gold SPDT/ 6.35 mm	50 mΩ max	125 Vac 30 Vdc 0,1 A	5 Vdc 1 mA	1000	±12	45±15	-	-	-	-	±20	60±15	±70	N.D.		
V-5610RK-061	Gold SPDT/ 6.35 mm	500 mΩ max	125 Vac 30 Vdc 0,1 A	125 Vac 24 Vdc 10 mA	600	±9	27±7	-	-	±20	50±18	-	-	N.A.	N.A.		
V-5620R-047	Silver SPST/ 6.35 mm	300 mΩ max	250 Vac 24 Vdc 1,5 A	125 Vac 24 Vdc 0,2 A	600	±9	15±8	-	-	±20	23±12	-	-	N.A.	N.A.		
V-5620R-048	Silver SPST/ 6.35 mm	100 mΩ max	250 Vac 5 A	125 Vac 24 Vdc 50 mA	1000	±9	25±15	-	-	-	-	±20	40±20	±70	N.D.		
V-5620RK-058	Gold SPST/ 6.35 mm	1000 mΩ max	125 Vac 30 Vdc 0,1 A	125 Vac 24 Vdc 10 mA	600	±9	17±6	-	-	±20	27±14	-	-	N.A.	N.A.		

S.A. = Setting Accuracy * Standard setting accuracy (can be improved with enhanced type versions. See page 6)

Diff. = Differential ** Optional 15 ± 8 (also for products manufactured before week 9608)

Because of the growing use of electronic contact sensing, apart of the maximum contact rating, also attention should be paid to the minimum contact rating of voltage and current for the maximum reliability.

DIMENSIONAL DRAWING

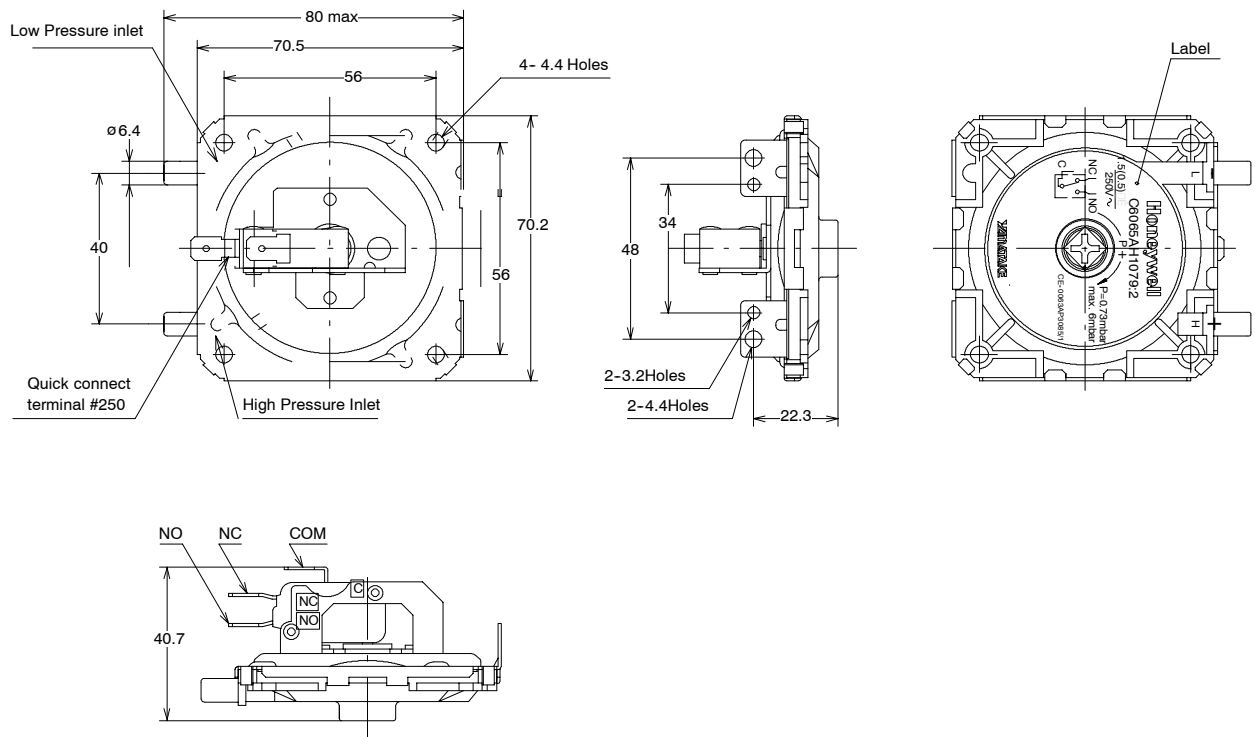

Fig. 5. dimensional drawing

INSTALLATION

When installing this product:

- Ensure installation is performed by trained service technicians.
- Follow all appliance instructions carefully. Failure to follow them could damage the product or cause a hazardous condition.
- Check that this product has the required pressure and electrical rating for the application.
- On completing the installation, check that all components operate correctly.

WARNING

Products of combustion generally contain a large quantity of vapour and generate condensation within the device as it cools.

Condensate in the tubing or within the body of the C6065 can cause pressure control point offset.

Condensate can also damage metal parts of the device, making replacement necessary.

When used as primary safety control, the C6065 must be part of a safe start circuit.

Location

To prevent condensate damage, the following procedure should be observed when mounting the C6065:

- Mount C6065 with the pressure connections at the bottom so that condensate does not penetrate into the device.

- Provide condensate drainage by gradually sloping tubing towards the exhaust pressure inlet (fig. 7.)
- If suitable drainage is not possible then a drip leg should be installed

Since combustion products are normally at a high temperature, special consideration to piping length and mounting location should be given so that the pressure port surroundings are not subjected to ambient temperature in excess of 90 °C.

Select a location that does not subject the C6065 to severe vibration and that allows convenient connection of electrical wiring and pressure tubing.

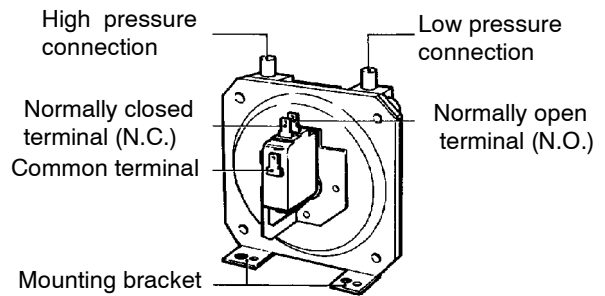

Fig. 6. C6065 general arrangement

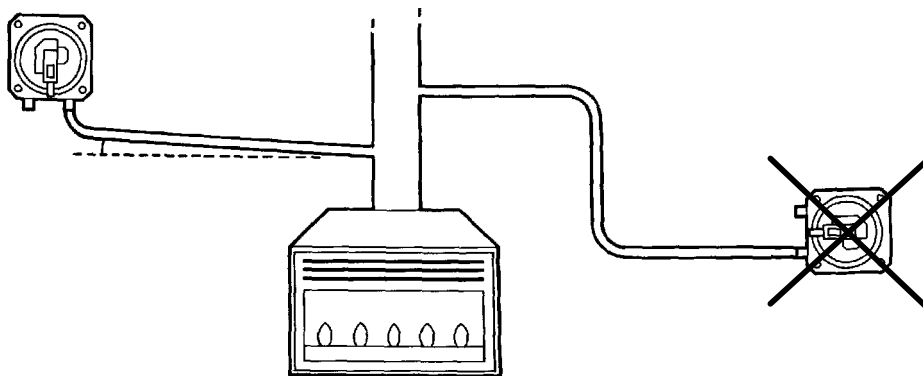

Fig. 7. Condensate drainage

MOUNTING

WARNING

Never use the four body holes of the pressure switch for mounting purposes (see fig. 10.)

The C6065 should be fixed in place using two M4 self tapping screws.

There are two mounting options (see fig. 8. and 9.):

Fig. 8.: front mounting

Fig. 9.: rear mounting

Mounting dimensions are also shown in fig. 8. and 9.

Piping

The outer diameter of the sensing pipe connection are 6.4 mm (see dimensional drawing page 9)

For connection tube 5 mm inner diameter plastic or rubber tube is recommended.

When selecting a tube, make sure that it has sufficient pull strength (independent of ambient temperature change).

Use gradual turns in the piping route avoiding sharp bends to ensure sensing of the correct pressure.

When sharp bends are unavoidable, a special durable tube with integrated reinforcement should be used.

Do not use for mounting purposes (4)

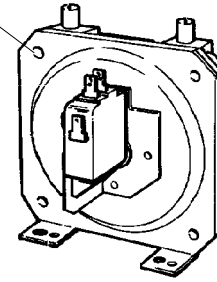

Fig. 10. C6065 general arrangement

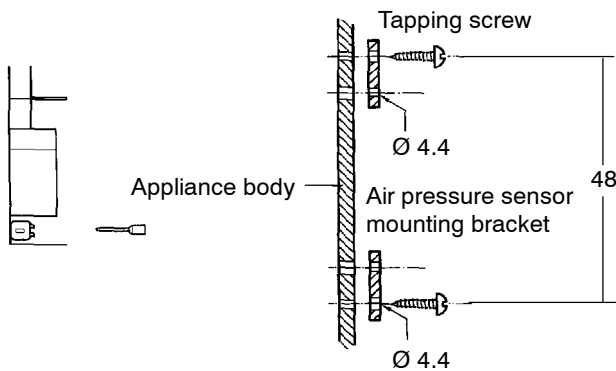

Fig. 8. Front mounting methods and dimensions

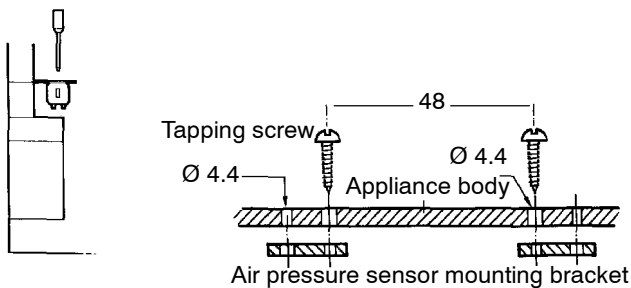

Fig. 9. Rear mounting methods and dimensions

WIRING

WARNING

Disconnect power supply before making any wiring connections.
All wiring must be in accordance with local regulations.
When making connections to the switch terminals, do not force the switch upwards or downwards to bend the terminals (figure 11.).
This may affect the pressure operating point.
Avoid locations where the terminals can be exposed to splashes of water.

The switch terminals are 6.35 mm Amp Nr 250 quick connector.

Safe start check circuit

When the C6065 is used as a primary safety control (fan interlock), it must be part of a safe start check circuit. A safe start check circuit will not allow the burner to operate unless the pressure switch contacts are in the correct position before the burner cycle begins. This ensures that the pressure switch and the control circuit are operating properly.

CAUTION

To guard against the possibility of electrical shock, the metal case must be either be connected to a protective earth or mounted inside the appliance, where it can only be accessed with the use of a tool.

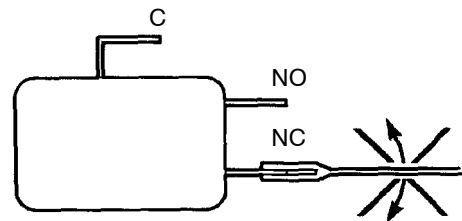

Fig. 12. Forcing terminals may affect operating point

QUALITY ASSURANCE

Products are manufactured under an ISO 9001 based and certified quality system.

The quality system is described in the Yamatake-Honeywell Control Products Division Quality Assurance Program and it is related operational procedures and instructions.

The quality organisation is responsible for defining, improving and verification of the quality systems in the field of design, production process and field quality service.

Assembly process are guided by work instructions. At the end of assembly phase, all differential pressure switches are leakage and performance tested/adjusted.

Shipping inspection is performed by employees of production department who are responsible for quality, using their own equipments.

All inspections (incoming and assembly) are performed by trained personel and according inspection procedures.

STANDARDS AND APPROVALS

Standards:

The C4065/C6065A series have been designed according to the German standard DIN 3398 part 2, and to the european draft standard prEN 1854.

Approvals:

The C6065A pressure switch has german approval DIN-DVGW 88.06.b050 valid until 1998).

The C4065A, AH, F, FH/C6065A, AH, F, FH pressure switches have been approved (CE) based on the essential requirements of the Gas Appliance Directive and CEN/TC 58/WG 7 document prEN 1854. (PIN: CE-0063AP3085/1).

In addition the pressure switches meet the relevant electrical requirements and have been tested at KEMA and/or VDE.

The C4065/C6065 pressure switch series conform the following EC-directives:

Gas Appliance Directive (90/396/EEC)

Low Voltage Directive (73/23/EEC)

Electro Magnetic Compatibility Directive (89/336/EEC)

Reference to manufacturer's declaration of conformity can be found in the CCC approvals list.

ORDERING INFORMATION

When ordering specify:

- Model number of differential pressure switch required: see fig. 13.
- Order number of accessories required.
- Assembled shape.
- Mounting position.
- CO point, OFF point, ON point, maximum ON point.
- Micro-switch type or electrical rating.

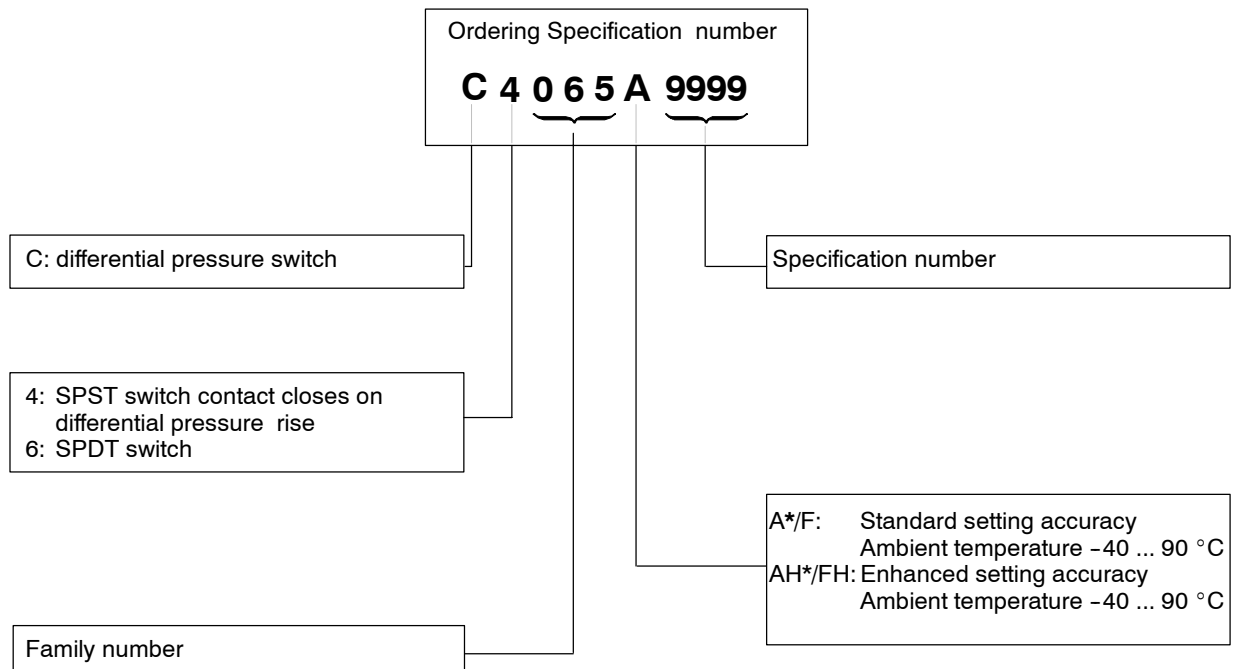

* A/AH produced before week 8, 1996 have ambient temperature -10 ... 70 °C (Date code 9608 printed on product)

Fig. 13. Model number chart

ACCESSORIES

Cap

To be used with free adjustable air pressure switches
(protection on the adjustment screw only)

Order number: 81403406-001

Packing quantity: 100

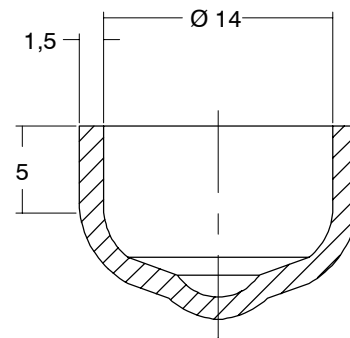

Fig. 14. Cap

Calibrate orifice

To prevent change-over on very short pick of pressure

Order number: 81405256-001

Packing quantity: 100

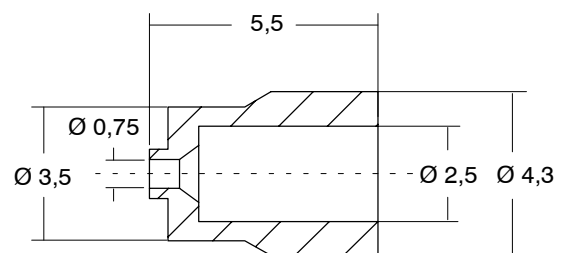

Fig. 15. Orifice

Honeywell

Home and Building Control
Combustion Controls Center Europe
Honeywell BV
Phileas Foggstraat 7
7821 AJ Emmen
The Netherlands
Tel: +31 (-)591 695911
Fax: +31 (-)591 695200
<http://europe.hbc.honeywell.com>

 **AutomatikCentret**
Strandvejen 42 • Saksild • 8300 Odder
86 62 63 64 • www.automatikcentret.dk
info@automatikcentret.dk