

VBG2 and VBG3 Ext. Threaded Control Ball Valves

for Use with MVN (DN15-32) and M6061/M7061 (DN40-50) Rotary Actuators

MOUNTING INSTRUCTIONS

1

VBG 2-WAY and 3-WAY VALVES

DN15...32

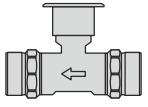

DN15...32

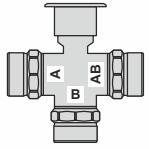

DN40-50

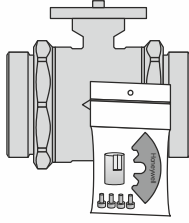

DN40-50

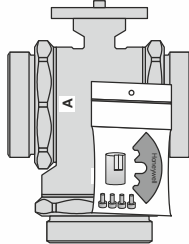

SUITABLE ACTUATORS

MVN (3-Nm)
ROTARY VALVE ACTUATORS
FOR DN15...32

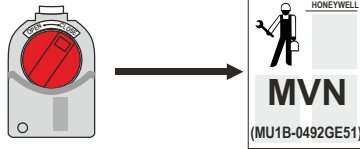

M6061 (10-Nm) and M7061 (10-Nm)
ROTARY VALVE ACTUATORS
FOR DN40-50

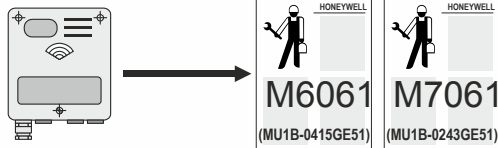



2



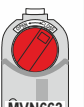

230 VAC

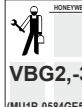



NOMINAL PRESSURE RATING:
PN25

CONTROLLED FLUID:
CHILLED / HOT WATER AS PER VDI2035,
WITH UP TO 50% GLYCOL.
NOT FOR USE WITH STEAM OR FUELS.

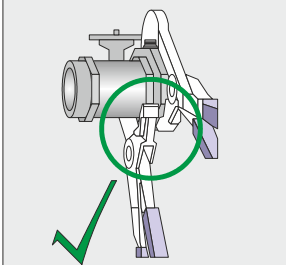

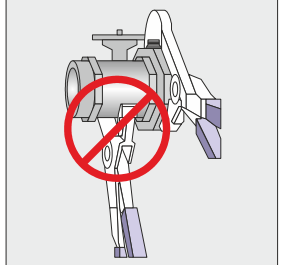

3

**MVN
DIN15...32**

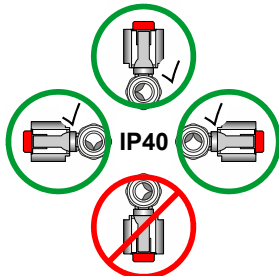

**M6061/7061
DIN40-50**

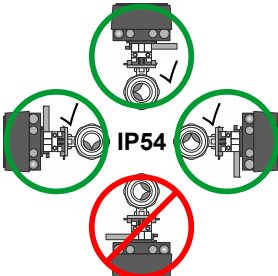

APPLICATIONS

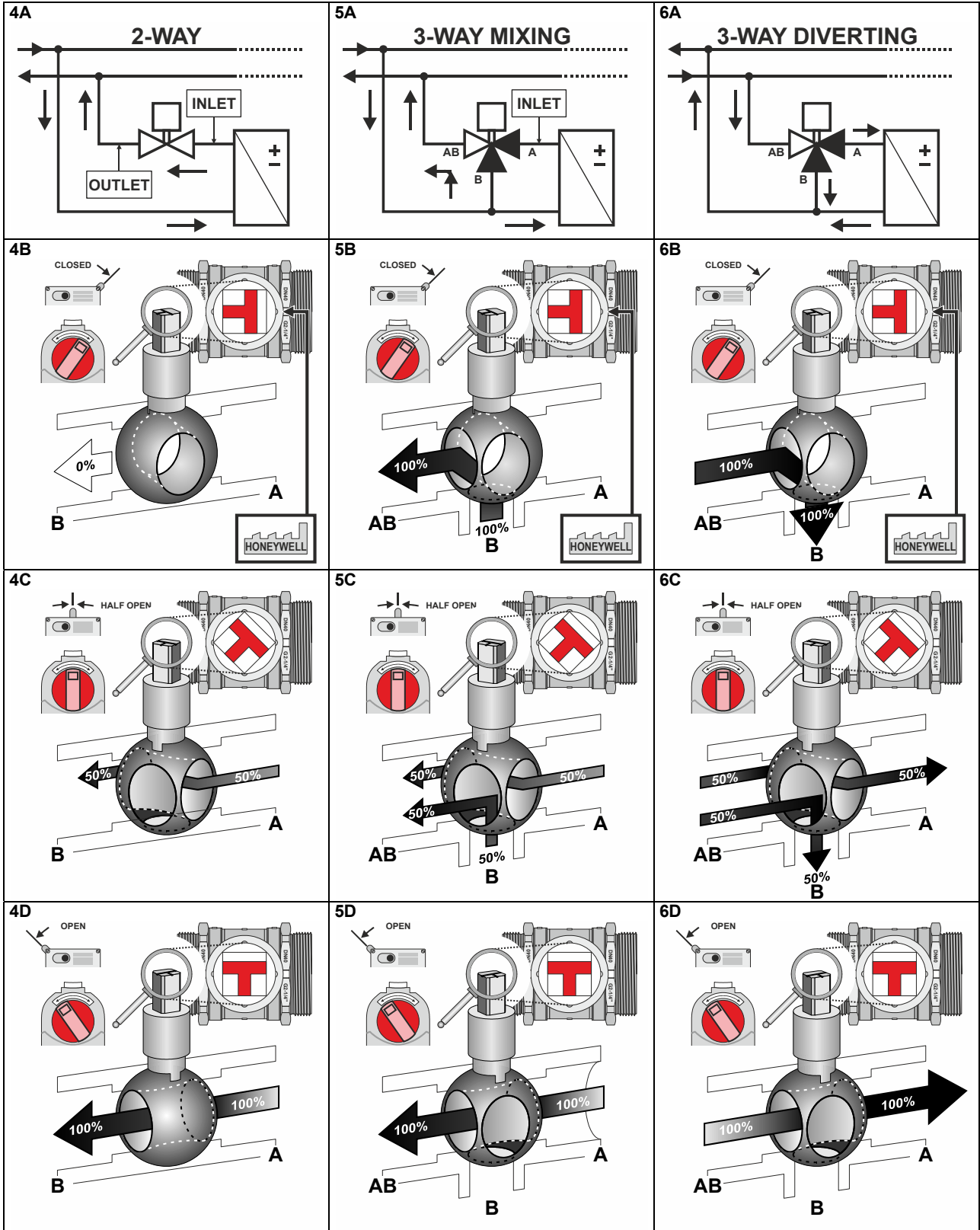

MOUNTING / DISMOUNTING

7: TWO- AND THREE-WAY VALVES (DN15...32)

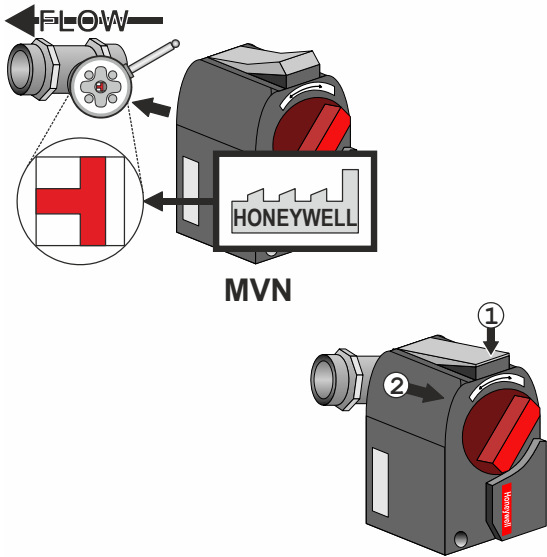

8: TWO- AND THREE-WAY VALVES (DN40-50)

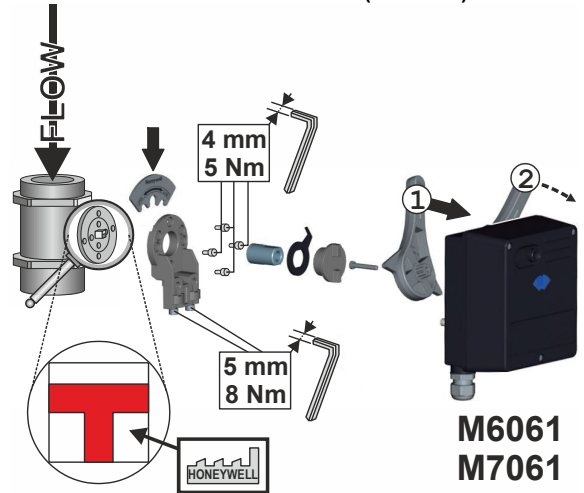

LINKAGE POSITIONS FOR M6061/M7061

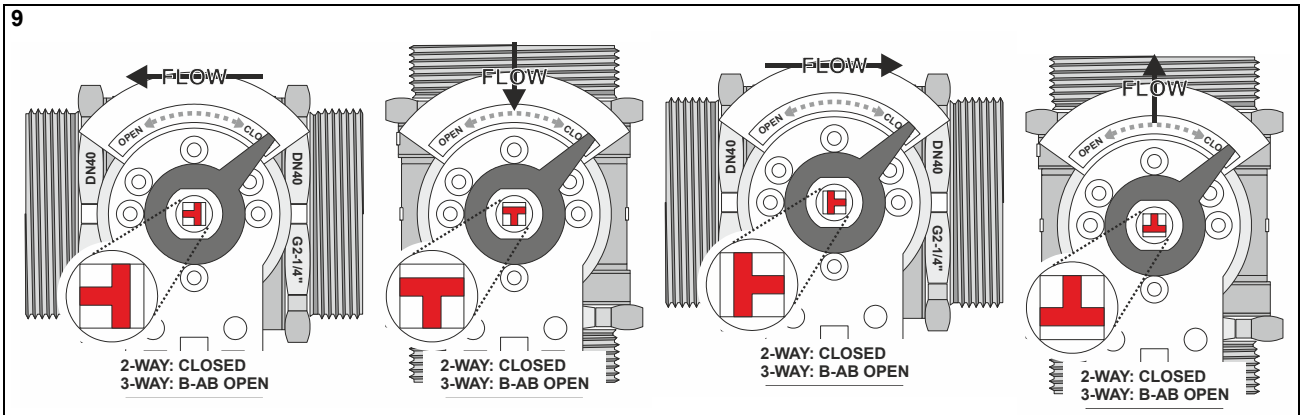

CONNECTION SET

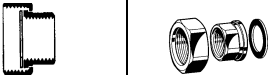
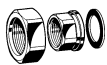
connection	pipe size	DN	order number	connection set		description
internal thread	R 1/2"	15	AC-15TF-1			consisting of 1 union nut, 1 tailpiece, and 1 gasket
	R 3/4"	20	AC-20TF			
	R 1"	25	AC-25TF			
	R 1-1/4"	32	AC-32TF			
	R 1-1/2"	40	AC-40TF			
	R 2"	50	AC-50TF			

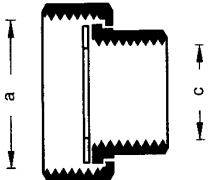
dimensions of connection sets			order number
	a	c	
	G 1"	G 1/2"	AC-15TF-1
	G 1-1/4"	G 3/4"	AC-20TF
	G 1-1/2"	G 1"	AC-25TF
	G 2"	G 1-1/4"	AC-32TF
	G 2-1/4"	G 1-1/2"	AC-40TF
	G 2-3/4"	G 2"	AC-50TF

DISPOSAL OF VBG CONTROL BALL VALVES

OBSERVE LOCAL REQUIREMENTS ON PROPER WASTE RECYCLING / DISPOSAL!

- Dezincification-resistant brass body
- Chrome-plated brass ball
- Teflon® seals with EPDM O-rings
- Noryl® flow control insert
- Stainless steel screws
- Aluminum DN 40/50 plate and adapter
- PA6.6 + 30% GF Plastic DN 40/50 scale
- PE Plastic bag for DN40/50 linkage parts

Honeywell

Manufactured for and on behalf of the Environmental and Combustion Controls Division of Honeywell Technologies Sàrl, Rolle, Z.A. La Pièce 16, Switzerland by its Authorized Representative:

Automation and Control Solutions

Honeywell GmbH
 Böblinger Strasse 17
 71101 Schönaich, Germany
 Phone +49 (0) 7031 637 01
 Fax +49 (0) 7031 637 740
<http://ecc.emea.honeywell.com>

 **AutomatikCentret**

Strandvejen 42 ♦ Saksild ♦ 8300 Odder
 86 62 63 64 ♦ www.automatikcentret.dk
info@automatikcentret.dk