

### OPERATING INSTRUCTIONS

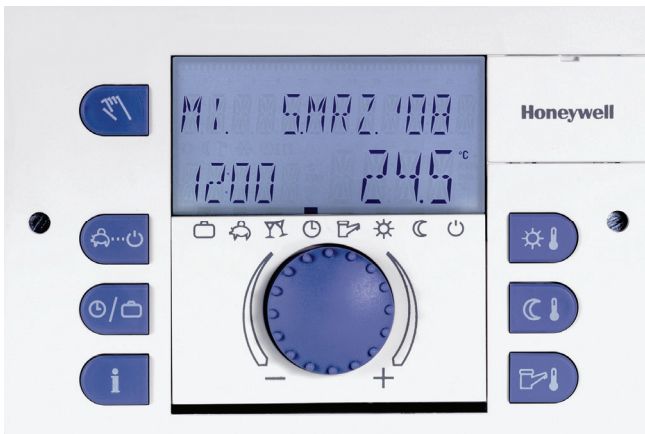



## Contents

<b>1</b>	<b>Software version</b> .....	<b>7</b>
<b>2</b>	<b>Safety instructions</b> .....	<b>7</b>
2.1	Intended use .....	7
2.2	Requirements for start-up .....	7
2.2.1	Power supply .....	8
2.2.2	Connection conditions .....	8
2.2.3	Cable cross-sections .....	8
2.2.4	Maximum cable lengths .....	8
2.2.5	Cable installation .....	8
2.2.6	Grounding and zeroing .....	9
2.3	Hot-water temperature greater than 60 °C .....	9
2.4	Connection of accessory parts .....	10
2.5	Maintenance and cleaning .....	10
<b>3</b>	<b>Overview</b> .....	<b>11</b>
<b>4</b>	<b>Operation</b> .....	<b>12</b>
4.1	Display and operating elements .....	12
4.1.1	Display (basic display) .....	13
4.1.2	Operating elements .....	14
4.1.2.1	Input button (press / turn) .....	14
4.1.2.2	"Daytime room temperature" button .....	14
4.1.2.3	"Night-time room temperature" button .....	15
4.1.2.4	"Daytime hot-water temperature" button .....	15
4.1.2.5	"Operating mode" button (basic display) .....	16
4.1.2.6	"Switching time programs / Holiday programs" button .....	23
4.1.2.7	"System information" button .....	26
4.1.2.8	"Manual mode" / "Emission measurement" button .....	28
4.1.2.9	Heating curve .....	30
4.2	Menu-selection level .....	31

---

4.2.1	"Time - Date" menu .....	33
4.2.2	"Timeprograms" menu .....	34
4.2.2.1	Selection of the control circuit .....	35
4.2.2.2	Selection of the program .....	35
4.2.2.3	Selection of day of the week and cycle .....	35
4.2.2.4	Programming switching times and cycle temperatures.....	36
<b>Block programming</b> .....		<b>44</b>
4.2.3	"System Parameters" menu .....	51
4.2.3.1	Language selection .....	51
4.2.3.2	Time program .....	52
4.2.3.3	Operating mode.....	52
4.2.3.4	Summer / Heating limit .....	54
4.2.3.5	Parameter reset.....	55
4.2.4	"DHW" menu .....	56
4.2.4.1	Night-time hot-water temperature .....	56
4.2.4.2	Legionella protection day .....	56
4.2.5	"Direct Heating Circuit" / "Mixed Heating Circuit 1" / "Mixed Heating Circuit 2" menu .....	57
4.2.5.1	Reduced operation .....	57
4.2.5.2	Heating system.....	58
4.3	Error messages.....	59
<b>5</b>	<b>Log</b> .....	<b>60</b>





## 1 Software version

This documentation is valid for software version **V 3.1** of your control device. The software version is displayed after switch-on for approx. 8 s. If you are using an older software version, please contact your heating technician.

## 2 Safety instructions

### 2.1 Intended use

The SDC / DHC Smile family of controllers was designed for the sole purpose of regulating and controlling hot-water, heating and district heating systems (including hot-water production) that do not exceed a maximum flow temperature of 120 °C.

### 2.2 Requirements for start-up

#### **▲ ATTENTION**

**The heating system must be complete and filled with water so that the pumps do not run dry and the heating boiler is not damaged.**

**The control equipment must be installed in accordance with the installation instructions.**

**All electrical connections (voltage supply, burner, mixer motor, pumps, sensor wiring etc.) must be carried out by the technician in accordance with the applicable VDE regulations and correspond with the circuit diagrams.**

**If floor heating is connected, a limiting thermostat must also be installed in the flow line after the heating circuit pump. This switches off the pumps at excessive flow temperatures.**

**Before starting up the controller, have the heating technician check all requirements listed above.**

**NOTE** The current time and date are already set at the factory and are backed up by a battery.

The time switch functions based on a basic program and the control functions are preset for common heating systems with low-temperature boilers.

### 2.2.1 Power supply

Do not disconnect the controller from the mains supply!

The battery for saving all individualised data is otherwise unnecessarily strained. The frost-protection function of the controller is deactivated.

### 2.2.2 Connection conditions

All electrical connection work may only be carried out by qualified personnel!

### 2.2.3 Cable cross-sections

**1.5 mm<sup>2</sup>** for all cables carrying 230 V (power supply, burner, pumps, actuator).

**0.6 mm<sup>2</sup>** for bus cables (recommended type J-Y(St)Y 2 x 0.6)

**0.5 mm<sup>2</sup>** for sensors, selectors and analog signal cables.

### 2.2.4 Maximum cable lengths

#### Sensor, selector and analog inputs

We recommend using cables no longer than 200 m. Longer connection lines could be used, but increase the risk of interference.

#### Relay outputs

Unlimited cable length.

#### Bus connections

Max. length of 100 m from the first bus subscriber to the last one (incl. wall modules).

### 2.2.5 Cable installation

Install cables for sensors apart from the cables carrying 230 V!  
Branch boxes in the sensor cable must be avoided!



### 2.2.6 Grounding and zeroing

Local regulations on the connection of equipment must be observed!

### 2.3 Hot-water temperature greater than 60 °C

#### ATTENTION

**Note that there is a danger of scalding at all hot-water draw-off points (kitchen, bathroom etc.) in the following cases. Add sufficient cold water in these cases.**

#### **Automatic anti-legionella mechanism**

When the automatic anti-legionella mechanism is activated, the hot water is automatically heated to the anti-legionella temperature (65 °C at the factory) on the selected day and at the selected time to kill any legionella bacteria found in the hot-water tank.

#### **Manual mode / Emission measurement**

In the manual mode / emission measurement operating mode, the hot water is heated up to the highest possible boiler temperature, as the burner and all pumps are switched on and the mixer is opened fully. There is an acute danger of scalding at all connected hot-water draw-off points! Add sufficient cold water or switch off the hot-water loading pump (at the switch of the pump, if present). Heating and hot water are in unregulated continuous operation. This operating mode is for special use by the chimney sweep for emission measurement or if the controller is defective. The high hot-water temperatures can be prevented, however, by setting the boiler thermostat to a max. boiler temperature of approx. 60 °C.

## 2.4 Connection of accessory parts

### **WARNING**

According to VDE 0730, a separator for each mains terminal is to be provided in the voltage supply to the control equipment. Observe the local regulations regarding grounding and zeroing.

As soon as the mains voltage is applied to terminals 21, 22, 2, 6, 12 and 18, headers X3 and X4 can also carry mains voltage.

If the heating circuit and hot-water loading pumps do not have an On / Off switch, but manual switch-on and switch-off capability is still desired, the appropriate switches must be installed by the customer. All accessory parts (sensors, selectors etc.) are to be connected to the respective circuit diagram.

## 2.5 Maintenance and cleaning

The controller is maintenance-free. The device can be cleaned externally with a moist (not wet) cloth.

### 3 Overview

The modular SDC / DHC control device is available in an installable switch cabinet version and a surface-mounted wall version with the following equipment features:

Type	Number of output relays	Burner stage 2 or District heating valve CLOSED	Burner stage 1	Direct heating circuit Variable output 3	Mixed heating circuit 1	Mixed heating circuit 2	Tank loading pump	Variable output 2	Variable output 1
SDC 3-10	3	–	x	x	–	–	x	–	–
SDC 3-40	3	–	–	–	x	–	–	–	–
SDC 7-21 <sup>1)</sup>	7	–	x	x	x	–	x	–	–
SDC 9-21 <sup>2)</sup>	7 + two variable relays	x	x	x	x	–	x	x	x
SDC 12-31 <sup>3)</sup>	10 + two variable relays	x	x	x	x	x	x	x	x

<sup>1)</sup> DHC 43-1

<sup>2)</sup> DHC 43-2

<sup>3)</sup> DHC 43-3

## 4 Operation

### 4.1 Display and operating elements

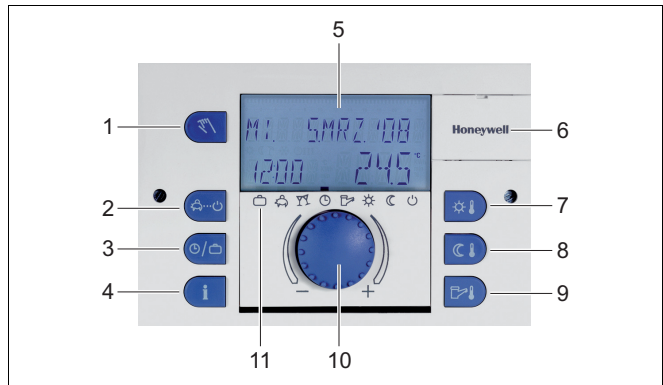

- 1 "Manual mode" / "Emission measurement" button (not on district heating controllers)
- 2 "Operating modes" button (basic display)
- 3 "Switching time programs" / "Holiday programs" button
- 4 "System information" button
- 5 Display
- 6 Cover clip for service socket
- 7 "Daytime room temperature" button
- 8 "Night-time room temperature" button
- 9 "Daytime hot-water temperature" button
- 10 Input button (press / turn)
- 11 Operating mode symbols (heating programs)

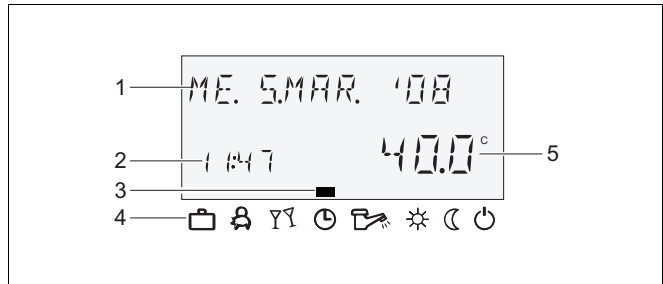

### 4.1.1 Display (basic display)



- |   |                        |   |                            |
|---|------------------------|---|----------------------------|
| 1 | Day of the week / Date | 4 | Operating mode symbols     |
| 2 | Time                   | 5 | Heat generator temperature |
| 3 | Active operating mode  |   |                            |

The illumination of the display is switched on by pressing any button or using the input button  and switches off automatically if no buttons are pressed for a longer period of time.

During start-up of the unit and after a power failure, a segment test with automatic fault diagnosis is carried out. The respective device type and the software version number then appear briefly.

The basic display that then appears shows the day of the week, the date, the time and the heat generator temperature in **automatic mode**. Different values appear in the basic display depending on the set operating mode (AUTOMATIC, PARTY etc.). Thus, for example, in the ABSENT operating mode, the indication ABSENT TIL appears instead of the date and the return date instead of the temperature. Active summer deactivation is indicated by a beach umbrella symbol , and active frost protection is indicated by a snowflake symbol .

## 4.1.2 Operating elements

### 4.1.2.1 Input button (press / turn)



By pressing once, you can:

- Confirm input / values

By pressing and holding (approx. 3 s), you can:

- Switch to the menu-selection level
- Move up one menu level

By turning the input button , you can:

- Change values (clockwise increases called-up values, anticlockwise decreases them)
- Navigate through menus

### 4.1.2.2 "Daytime room temperature" button





Sets the desired room temperature (room setpoint) in automatic mode during the heating cycles and in the PARTY and HEATING operating modes. In operating mode 1, the set value for all heating circuits is the same. In operating mode 2, the set value applies for the respective heating circuit. To set the operating mode, see 4.2.3.3 Operating mode, pg. 52.

#### Setting

▶ Press  button.

▶ Set flashing room temperature specification to the desired value by turning the input button .

▶ Confirm set value by pressing the  button or the input button .

Alternative: Automatic acceptance of the value after the set information time (see 4.1.2.7 "System information" button, pg. 26).

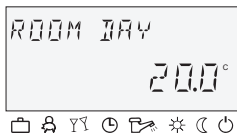

**Factory setting** 20 °C

**Setting range** 5 ... 30 °C





#### 4.1.2.3 "Night-time room temperature" button



Sets the lowered room temperature in automatic mode between the heating cycles and in the ABSENT and RED. HEATING operating modes.

In operating mode 1, the set value for all heating circuits is the same. In operating mode 2, the set value applies for the respective heating circuit. To set the operating mode, see 4.2.3.3 Operating mode, pg. 52.

##### Setting

- ▶ Press  button.
- ▶ Set flashing room temperature specification to the desired value by turning the input button .
- ▶ Confirm set value by pressing the  button or the input button .



Alternative: Automatic acceptance of the value after the set information time (see 4.1.2.7 "System information" button, pg. 26).

**Factory setting** 16 °C





**Setting range** 5 ... 30 °C

#### 4.1.2.4 "Daytime hot-water temperature" button



Sets the daytime hot-water temperature during the hot-water operational-readiness times in automatic mode and in the PARTY and HEATING operating modes. This set value also applies for exclusively hot-water operation (manual summer operation).

##### Setting

- ▶ Press  button.
- ▶ Set flashing hot-water temperature to the desired value by turning the input button .
- ▶ Confirm set value by pressing the  button or the input button .

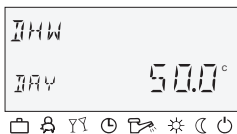

Alternative: Automatic acceptance of the value after the set information time (see 4.1.2.7 "System information" button, pg. 26).

**Factory setting** 50 °C

**Setting range** 5 °C (hot-water economy temperature) ... Maximum hot-water heater temperature limit (service setting)

**One-time hot-water circuit loading**



Pressing and holding (approx. 3 s) the  button brings you to the reload function, where the reload time can be set in minutes. With a reload time of 0 minutes, loading is started once and the hot-water tank is loaded to the daytime setpoint. The time for this superimposed hot-water circuit loading can be set between 0 and 240 minutes. The current week program is superimposed here.











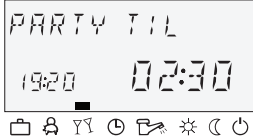

**4.1.2.5 "Operating mode" button (basic display)**

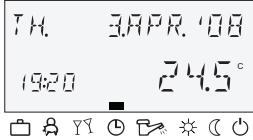

Sets the operating mode and returns to the basic display from every operating level.





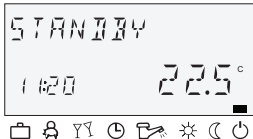



## Overview of the operating modes

Symbol	Operating mode	Display	Setting
	ABSENT		P1 (P2, P3)*, return date
	PARTY		P1 (P2, P3)*, party end time
	AUTOMATIC		P1 (P2, P3)*
	SUMMER		P1(P2, P3)*
	HEATING		
	RED. HEATING		
	STANDBY		

\* P2 and P3 only after enabling, see "System Parameters" menu, parameter 2 = P1 to P3

The selected operating mode appears in plain text, whereby a marking at the bottom edge of the display points to the respective operating mode symbol at the same time. In operating mode 1, the set value for all heating circuits is the same. In operating mode 2, the set value applies for the respective heating circuit. To set the operating mode, see 4.2.3.3 Operating mode, pg. 52.

- Setting**
- ▶ Press  button.
  - ▶ Select operating mode by turning the input button . The marking is located above the corresponding operating mode symbol.
  - ▶ Confirm set operating mode by pressing the  button or the input button .
  - ▶ With short-term operating modes (ABSENT, PARTY), set the desired value by turning the input button  and confirm with the  button or the input button .

Alternative: Automatic acceptance of the value after the set information time (see 4.1.2.7 "System information" button, pg. 26).

**Return to the basic display** Press the  button for approx. 3 s to return to the basic display from any operating level.

**NOTE** Holiday mode is set via the "Switching time programs / Holiday programs" button (see 4.1.2.6 "Switching time programs / Holiday programs" button, pg. 23).

#### 4.1.2.5.1 Absence mode (short-term program)





With the ABSENT operating mode, heating operation is temporarily deactivated and protected from frost during brief absences. During the absence, all heating circuits are adjusted to the specified lowered room temperature. Once the set time expires, the heating circuits automatically return to the operating mode that was active before the switch to the absence operation. Short-term programs such as PARTY or ABSENT are skipped here.

**Setting** See 4.1.2.5 "Operating mode" button (basic display) , pg. 16

**Application** Short absence while heating operation is active.

**Cancellation** An active absence program can be cancelled in case of early return.

- ▶ Press  button.
- ▶ Turn input button  and switch to automatic operation.  
The active absence program has been cancelled.

**Factory setting** P1 as from activation

**Setting range** P1 (P2, P3) / 0.5 to 24 h to the current time

#### **P1 (P2, P3)**

Program-controlled resumption of heating operation. After activation of the absence program, heating operation is interrupted until the following switch-on time of the current automatic program P1 (or P2 or P3, if enabled).

#### **0,5 ... 24 h**

The set value is added on to the current time and represents the return time. When the absence program is called up again, the last set value is saved and suggested as the initial value.

**Display** An active absence program appears in the basic display with information on the return time.

#### **4.1.2.5.2 Party mode (short-term program)**

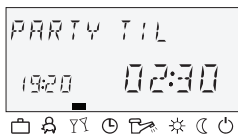



Party mode causes one-time intermediate heating of all heating circuits up to a specified point in time and bridges an upcoming or already active absence cycle totally or partially. Once the set time expires, the heating circuits automatically return to the operating mode that was active before the party program. Short-term programs such as ABSENT or PARTY are skipped here.

**Setting** See 4.1.2.5 "Operating mode" button (basic display) , pg. 16

**Application** One-time extension of heating operation or intermediate heating during lowering operation outside the schedule.

**Cancellation** An active party program can be cancelled early.

- ▶ Press  button.
- ▶ Turn input button  and switch to automatic mode.  
The active party program has been cancelled.

**Factory setting** P1 as from activation

**Setting range** P1 (P2, P3) / 0.5 to 24 h to the current time P1

### P1 (P2, P3)

Program-controlled resumption of heating operation. After activation of the party program, heating operation is continued until the following switch-on time of the current automatic program P1 (or P2 or P3, if enabled)

### 0,5 ... 24 h

The set value is added on to the current time and represents the end of the party time. When the party program is called up again, the last set value is saved and suggested as the initial value.

**Display** An active party program appears in the basic display with information on the party end time.

#### 4.1.2.5.3 Automatic mode

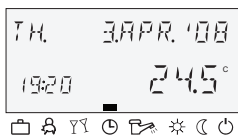

In automatic operation, max. three time programs with different heating operation times are available. They are called up during start-up as factory-set and unlosable default programs P1, P2 or P3 and can, if necessary, be overwritten with their own switching times in the "Timeprograms" menu (see 4.2.2 "Timeprograms" menu, pg. 34).

**NOTE** Default programs P2 and P3 cannot be selected until the PROGRAM = P1 to P3 parameter is enabled in the "System Parameters" menu. Without enabling, only program P1 is active.

**Setting** See 4.1.2.5 "Operating mode" button (basic display) , pg. 16

### Disabling / enabling default program P2 to P3

#### Disabling

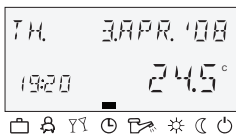

"System Parameters" menu, program parameter = P1. All heating circuits and the hot-water circuit solely refer to the default / individually programmed switching times in the program P1 parameter. Program P1 does not appear in the display in this operating mode (see 4.2.2 "Timeprograms" menu, pg. 34 and 4.2.3.2 Time program, pg. 52).

#### Enabling

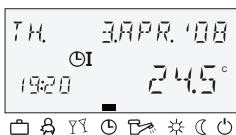

"System Parameters" menu, program parameter = P1 to P3 (see 4.2.2 "Timeprograms" menu, pg. 34 and 4.2.3.2 Time program, pg. 52).

#### Display

An active automatic program appears in the basic display with the current date and time. If default programs P2 and P3 were enabled, the corresponding symbol,  $\ominus\text{I}$ ,  $\ominus\text{II}$  or  $\ominus\text{III}$ , is also displayed depending on the selected program. The symbols are only displayed with the time program P1 to P3 active.

#### 4.1.2.5.4 Manual summer operation (excluding heating operation)

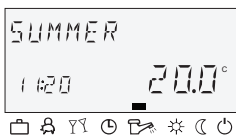

With manual summer operation, only the hot-water circuit remains operation and controls the heat generator temperature based on the specified hot-water temperature and the specified hot-water switching time program. Heating operation is stopped, and protection from frost is provided. This feature is only available when control mode is set to 1.

#### Setting

See 4.1.2.5 "Operating mode" button (basic display) , pg. 16

### Disabling / enabling default programs P2 to P3

#### Disabling



"System Parameters" menu, program parameter = P1. All heating circuits and the hot-water circuit solely refer to the default / individually programmed switching times in the time program = P1 parameter. Program P1 does not appear in the display in this operating mode (see 4.2.2.1 Selection of the control circuit, pg. 35 and 4.2.3.2 Time program, pg. 52).

### Enabling

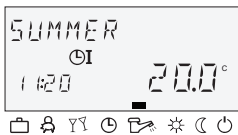

"System Parameters" menu, program parameter = P1 to P3 (see 4.2.2.1 Selection of the control circuit, pg. 35 and 4.2.3.2 Time program, pg. 52).

#### Display

Manual summer operation appears in the basic display with the information SUMMER. If default programs P2 and P3 were enabled, the corresponding symbol,  $\text{⓪I}$ ,  $\text{⓪II}$  or  $\text{⓪III}$ , is also displayed depending on the selected program. The symbols are only displayed with the time program P1 to P3 active.

#### 4.1.2.5.5 Continuous heating operation

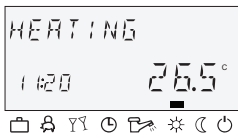

The HEATING operating mode ensures continuous heating operation without time limitations based on the specified daytime room temperature. Hot-water production occurs continuously based on the specified daytime hot-water temperature.

#### NOTE

The HEATING operating mode remains active until another operating mode is activated.

#### Display

Activated continuous heating operation appears in the basic display with the information HEATING.

#### 4.1.2.5.6 Continuous lowering operation



The RED. HEATING operating mode causes continuously reduced heating operation based on the specified lowered room temperature. On the heating circuit levels, the reduced operating mode ECO (frost-protected deactivation mode) or RED (lowering mode) is set accordingly. The minimum temperature limit of the respective heating circuit must be taken into account.

See the "Direct Circuit" or "Mixed Heating Circuit 1" / "Mixed Heating Circuit 2" menu, reduced parameter = reduced operation and 12 parameter = minimum temperature limit.

Hot-water production occurs continuously based on the specified hot-water economy temperature (see "DHW" menu, hot water parameter = hot water at night).

**NOTE** The RED. HEATING operating mode remains active until another operating mode is activated.

**Display** Activated continuous lowering operation appears in the basic display with the information RED. HEATING.

#### 4.1.2.5.7 Standby mode

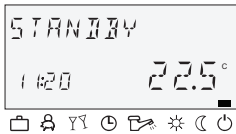

In standby mode, the entire system is switched off and protected from frost (all frost-protection functions active).

Hot-water production is disabled and protected from frost. At storage temperatures below 5 °C, a reload to up to 8 °C takes place.

**Application** Total deactivation of heating and hot water with full building protection.

**NOTE** The heat generator and hot-water production remain in operation in case of external demand or demand by other heating circuits on the bus network. The heating circuit pumps are switched on briefly every day (pump anti-blocking protection).

The standby mode remains active until another operating mode is activated.

**Display** Activated continuous standby mode appears in the basic display with the information STANDBY.

#### 4.1.2.6 "Switching time programs / Holiday programs" button



Using this button, you can create individualised switching time programs for heating and hot-water operation and set holiday mode.









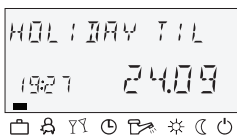

See 4.1.2.6.1 Holiday mode, pg. 24 and 4.2.2 "Timeprograms" menu, pg. 34.

#### 4.1.2.6.1 Holiday mode

In holiday mode, the heating circuits can be switched off and protected from frost or operated based on the settings for the RED. HEATING operating mode for the duration of the holiday based on the presetting ("Direct circuit" or "Mixed heating circuit 1" / "Mixed heating circuit 2" menu, parameter 25 = holiday operating mode).

##### Setting





- ▶ Press  button.  
The menu-selection level Switching time programs / Holiday programs appears in the display.
- ▶ Turn input button  to the left.  
HOLIDAY appears in the display.
- ▶ Press input button .  
HOLIDAY 01 appears in the display.
- ▶ Press input button .  
The year flashes in the display.
- ▶ Set year with the input button .
- ▶ Press input button .  
The day on which the holiday is to begin flashes in the display.
- ▶ Set the day the holiday will begin with the input button .
- ▶ Press input button .  
TIL - - appears in the display.
- ▶ Set the day you will return from holiday with the input button .
- ▶ Press input button .  
The desired holiday timeframe is saved.

You can now enter additional holiday timeframes (up to 15 holiday blocks).

**Application** Longer absence while heating operation is active.





- Control during holidays** At outside temperatures below the frost-protection limit (see 4.2.3 "System Parameters" menu, pg. 51) the heating circuits are controlled as follows:
- Without wall devices: Based on a lowered room temperature specification of 3 °C.
  - With wall devices: Based on the room frost-protection limit of the respective heating circuit of 10 °C (see "Direct Heating Circuit" or "Mixed Heating Circuit 1", "Mixed heating circuit 2" menu, parameter 08 = room frost-protection limit).
- Cancellation** An active holiday program can be cancelled in case of early return.
- To do so, the  and  buttons have to be kept pressed together until "Holiday off" is shown in the display.
- Factory setting** Current date
- Setting range** Current date... (current date + 250 days)
- Display** An active holiday program appears in the basic display with information on the return date.

#### 4.1.2.7 "System information" button



Calls up system information, such as temperatures and counter data.

The information on the outside temperature appears first after the  button is pressed. Turning the input button  causes the system temperatures and the counter and consumption states and operating states of the connected system components to appear. Pressing the input button  causes the respective setpoint values to appear.

<b>Exceptions</b>	Collector flow temperature:	No setpoint
	Solar tank temperature:	No setpoint
	Outside temperature:	Averaged value

**NOTE** The displayed information (see the following example) is independent of the installed or enabled system components and control circuits.

Operating overview

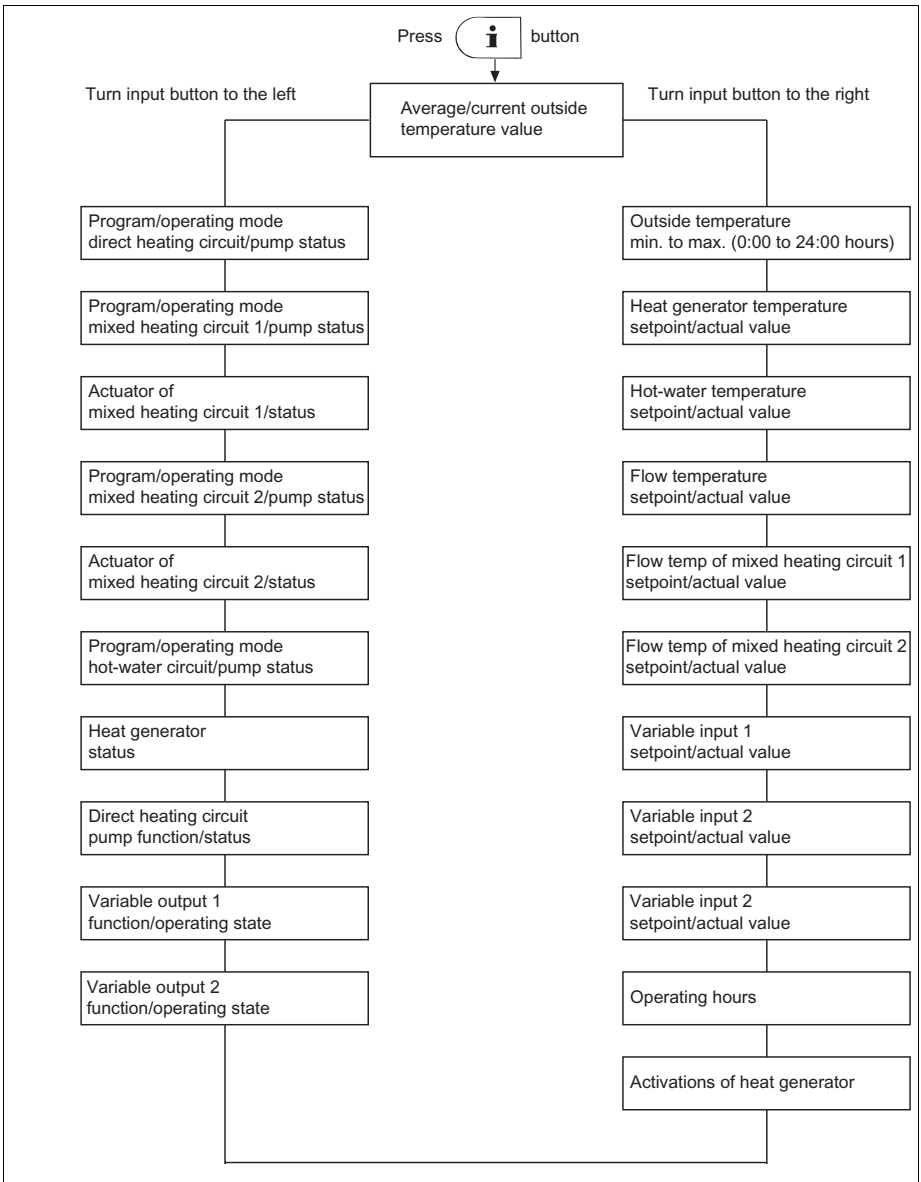

**Setting time for automatic return**

If the  button is pressed and held for approx. 3 s, the INFO TIME parameter appears.



With this parameter, the time it takes for automatic return to the basic display can be specified.

**Setting range**

- OFF No return. The last selected information display continuously remains in the basic display until the next change.
- 1 ... 10 min Automatic return from the information level after the specified time (in 0.5 minute increments).

**Factory setting**

OFF

**4.1.2.8 "Manual mode" / "Emission measurement" button**

**4.1.2.8.1 Manual mode**



If this button is pressed and held longer than 5 s in the basic display, the controller is switched to manual mode. In this operating mode, the required heat generator temperature is specified manually with the input button  according to the respective heating need.

A controller set to manual mode has no effect in heat circuit expansion.



The heat generator setpoint is set between the minimum and maximum heat generator temperatures and appears flashing at the bottom left-hand side. The current heat generator temperature appears statically on the right-hand side in the basic display. The set switching differential corresponds to the value of automatic control and is symmetrical to the set value.

**Application**

Controller malfunctions (emergency operation), errors

**NOTE**

The maximum heat generator temperature limit is paramount to the heat generator switching differential and stops the heat generator in case of exceedance.

With control devices operated purely as a heating circuit expansion, the setting of the temperature has no effect.

The last value to which the control device adjusted the heat generator temperature appears as a recommendation.

**Cancellation** Press  button or  button, to return to the last selected operating mode.

#### 4.1.2.8.2 Emission measurement (not with district heating controllers)

##### **ATTENTION**

**Emission measurements may only be carried out by the chimney sweep.**

Pressing the  button controls the heat generator for a duration of 20 min based on the set maximum temperature limit. The remaining time is displayed and counted down.



With two-stage heat generators, both stages are in operation (measurement at nominal output).

**Function** The heat generator is adjusted to the maximum heat generator temperature. All heating circuits and the hot-water production adjust their setpoint to the respective maximum temperature.

##### **ATTENTION**

**There is a danger of scalding by hot water, as the hot-water temperature can exceed the set setpoint temperature.**

**Application** Emission measurement by the chimney sweep.

**Cancellation** Emission measurement can be cancelled at any time with the  or  button.

#### 4.1.2.9 Heating curve

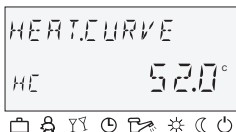

Determines the heating curve for the heating circuits.







The heating curve describes the relationship of the flow temperature change to the outside temperature change. With a larger heating surface, such as with floor heaters, the heating curve has a less extreme slope than with a smaller heating surface (e.g. radiators).

The set value refers to the lowest outside temperature used for heat demand calculation.

#### ⚠ ATTENTION

**This parameter must be set by the technician and should no longer be changed.**

#### Setting

- ▶ Press and hold input button  for 3 s.
- ▶ Turn the input button  to select the desired heating circuit (HC, MC-1 or MC-2) and confirm it by pressing the input button . The design temperature (system) appears at the bottom right-hand side of the display.
- ▶ Press input button . The slope of the heating curve appears at the bottom left-hand side of the display.
- ▶ Set the flashing heating curve value by turning the input button  (design temperature also flashes and is changed automatically depending on the slope of the heating curve).
- ▶ Confirm by pressing the input button .

Alternative: Automatic acceptance of the value after the set information time (see 4.1.2.7 "System information" button, pg. 26).

- ▶ Press  button to return to the basic display.

**Setting range** 0,2 ... 3,5

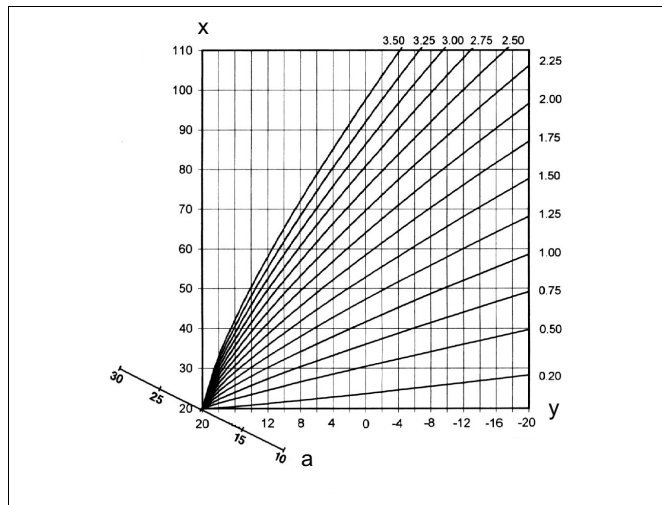

**Factory setting** Direct heating circuit (HC) = 1,5  
 Mixed heating circuit 1 (MC-1) = 1  
 Mixed heating circuit 2 (MC-2) = 1



x Boiler / flow temperature [°C]  
 y Outside temperature [°C]  
 a  $T_{room}$  [°C]

#### 4.2 Menu-selection level

The control device contains a menu-selection level that is structured differently, depending on the respective device version.

- Access**
- ▶ Press and hold input button  for approx. 3 s.  
The menu selection always begins with the TIME – DATE menu.
  - ▶ Turn input button  to select additional menus.
  - ▶ Press input button  to confirm the selected menu.

The menu functions are described in the following:

	Program- ming	Configuration	Configuration			
Parameter	Time - Date	System parameter	Hot water	Direct heating circuit	Mixed heating circuit 1	Mixed heating circuit 2
01	Time	Language selection	Nighttime hot water	Heating curve	Heating curve	Heating curve
02	Year	Time program	Legionella- protection day	Reduced	Reduced	Reduced
03	Day - Month	Operating mode	–	Heating system	Heating system	Heating system
04	Change	Summer / Heat limit	–	–	–	–
05	–	–	–	–	–	–
06	–	–	–	–	–	–
07	–	–	–	–	–	–
23	–	Parameter reset	–	–	–	–
Heating circuit name	–	–	–	Heating circuit name	Heating circuit name	Heating circuit name



### 4.2.1 "Time - Date" menu

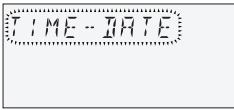

The following current calendar values can be specified in this menu:







- Time
- Year
- Day - Month
- Time change mode (summer / winter time)

**NOTE** All listed daytime values are set at the factory and generally do not need to be updated.

An internal, pre-programmed calendar ensures automatic time change on the annually recurring summer / winter time switchover dates. If necessary, the automatic time change can be deactivated. The current weekday, Mo to Su is determined from the calendar date and does not need to be set.

**Application** Corrections for rare fault cases

**Access** See 4.2 Menu-selection level, pg. 31

- Setting**
- ▶ Turn input button  and select the "Time - Date" menu.
  - ▶ Turn input button  and select the desired calendar value (time, year, day - month, change).
  - ▶ Press input button  and change the corresponding value by turning the input button .
  - ▶ Press input button  to confirm the set value.
  - ▶ Turn input button  to select and change additional calendar values.

**Returning** Returning to the basic display takes place by pressing the  button or automatically after the set information time (see 4.1.2.7 "System information" button, pg. 26).

#### 4.2.2 "Timeprograms" menu

Individualised switching time programs for heating and hot-water operation can be created in this menu. Here, the factory-set default programs P1 (and, if enabled, P2 and P3 as well) of each heating circuit and the hot-water circuit are overwritten by individualised switching times and temperature specifications. This is especially advantageous if correspondingly adapted heating programs are to be created in case of periodically recurring assignments with different assignment times (e.g. shift work). Max. three heating cycles, each with a switch-on and switch-off time, are available for each day of the week for programming switching times. Each heating cycle can also be combined with a freely-selectable temperature specification.

**NOTE** The default programs are not lost when overwritten by individually created programs. Individualised programs, however, are deleted when default programs are reloaded and must be recreated. For this reason, individualised switch-on / switch-off times and temperature specifications should always be entered in the tables provided for this purpose (see 5 Log, pg. 60).

**Access** Press  button.

**Returning** Returning to the basic display takes place by pressing the  button or automatically after the set information time (see 4.1.2.7 "System information" button, pg. 26).

#### 4.2.2.1 Selection of the control circuit

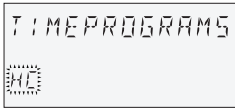

After accessing the "Timeprograms" menu, the desired control circuits can be selected with the input button  in the following sequence:

- Direct heating circuit (HC)
  - Mixed heating circuit 1 (MC-1)
  - Mixed heating circuit 2 (MC-2)
  - Hot-water circuit (DHW)
- ▶ Press input button  to access the selected circuit.



#### 4.2.2.2 Selection of the program

If the switching time programs P2 and P3 have been enabled (see "System Parameter" menu, program parameter = P1 to P3), the program selection appears.

If switching time programs P2 and P3 are disabled, program selection is automatically skipped (see "System Parameters" menu, program parameter = P1).

#### 4.2.2.3 Selection of day of the week and cycle

Once the program is selected, the first cycle of the first day of the week (MO 1) and the relevant section in the top time bar flash.

The other cycles are selected by turning the input button  and confirmed by pressing the input button .

#### 4.2.2.4 Programming switching times and cycle temperatures

##### 4.2.2.4.1 Switch-on time

The switch-on time is the start of heating or, with enabled switch-on optimisation, the start of assignment.

After selecting the day of the week and the corresponding cycle, the respective switch-on time appears flashing and can be set with the input button . The time bar in the top part of the display provides an overview of all programmed cycles between 0:00 and 24:00 hours on the selected day of the week.

**NOTE** The switch-on time cannot be set below the switch-off time of a previous cycle or below 0:00 hours of the selected day of the week.

If the switch-on time is changed, the corresponding time bar display is adjusted to the left-hand side.

If the switch-on time is made equal to the switch-off time, the corresponding cycle is deleted. A subsequent cycle is automatically shifted to the position of the deleted cycle upon acceptance.

With subsequent insertion of a cycle that has been bumped up, the corresponding day of the week must be reprogrammed.

A flashing switch-on time is accepted by pressing the input button .

##### 4.2.2.4.2 Switch-off time

The switch-off time is the end of heating or, with enabled switch-off optimisation, the end of assignment.

Once the switch-on time is accepted, the associated switch-off time appears flashing and can be changed with the input button . The time bar in the top part of the display provides an overview of all programmed cycles between 0:00 and 24:00 hours on the selected day of the week.

**NOTE** The switch-off time cannot be set higher than the switch-on time of a subsequent cycle.

If the switch-on time is changed, the corresponding time bar display is adjusted to the right-hand side.

If the switch-off time is made equal to the switch-on time, the corresponding cycle is deleted. A subsequent cycle is automatically shifted to the position of the deleted cycle upon acceptance.

With subsequent insertion of a cycle that has been bumped up, the corresponding day of the week must be reprogrammed.

A flashing switch-off time is accepted by pressing the input button .

#### 4.2.2.4.3 Cycle temperature

Once the switch-off time is accepted, the associated cycle temperature appears flashing and can be changed immediately with the input button . With heating circuits, the displayed cycle temperature is always based on the desired room temperature; with the hot-water circuit, it is based on the desired normal hot-water temperature in the selected cycle.

A flashing cycle temperature is accepted by pressing the input button .

At the same time, the last called-up cycle appears flashing so that it may be monitored; additional cycles can then be selected directly and edited in the same way in the order: switch-on time, switch-off time, cycle temperature.

**Switching time programming (programs P2 and P3 disabled)**

Upon accessing the menu-selection level, the "Timeprograms" menu always appears first.

Enabling of programs P2 and P3 in the "System Parameters" menu (see 4.2 Menu-selection level, pg. 31).

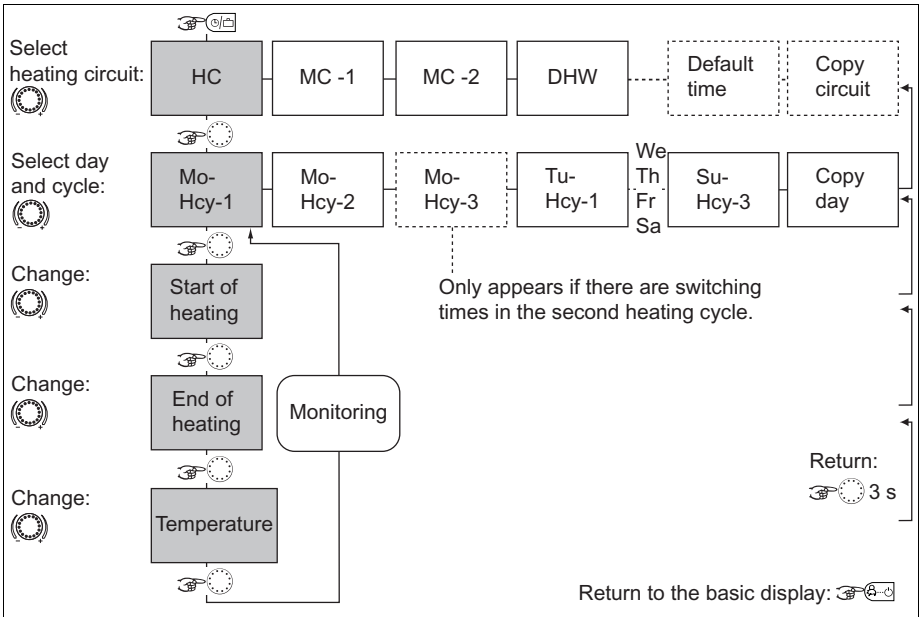

- HC      Direct heating circuit
- MC-1    Mixed heating circuit 1
- MC-2    Mixed heating circuit 2
- DHW     Hot-water heating circuit
- Hcy     Heating cycle

### Default switching time program (P1) for heating and hot water

Uniform, continuous heating and hot-water operation on all days of the week

Default program P1			
Heating circuit	Day	Heating operation	
		from	to
Heat generator heating circuit	Mo to Su	6:00	22:00
Hot-water circuit	Mo to Su	5:00	22:00
Mixed heating circuit 1 / 2	Mo to Su	6:00	22:00

**Switching time programming (program P2 and P3 enabled)**

Upon accessing the menu-selection level, the "Timeprograms" menu always appears first. Enabling of programs P2 and P3 in the "System Parameters" menu (see 4.2 Menu-selection level, pg. 31).

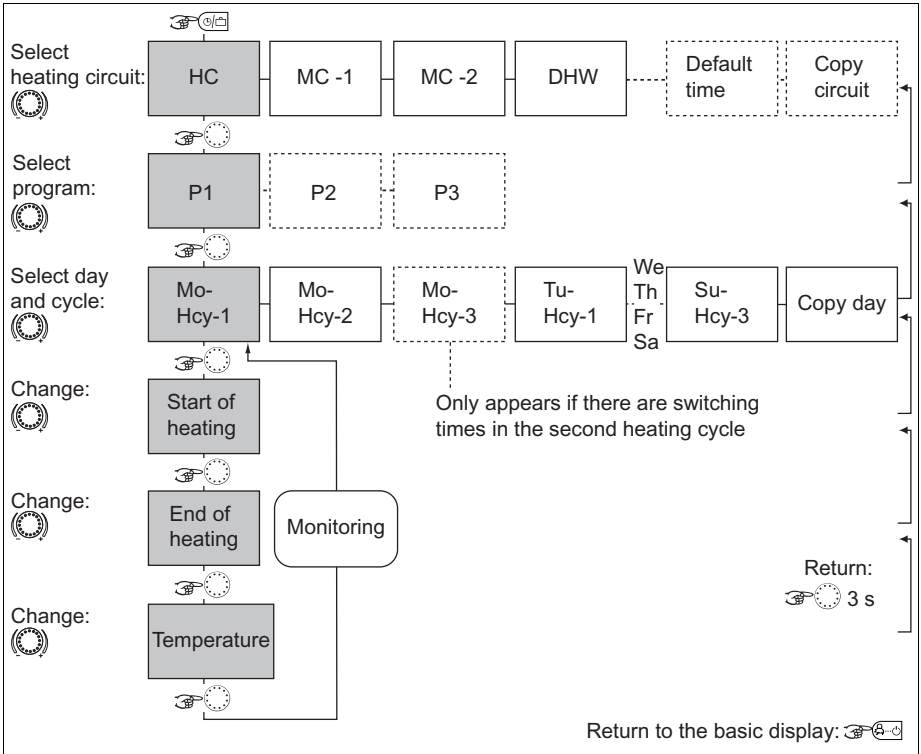

- HC Direct heating circuit
- MC-1 Mixed heating circuit 1
- MC-2 Mixed heating circuit 2
- DHW Hot-water heating circuit
- Hcy Heating cycle



Default program P1			
Heating circuit	Day	Heating operation	
		from	to
Heat generator heating circuit	Mo to Su	6:00	22:00
Hot-water circuit	Mo to Su	5:00	22:00
Mixed heating circuit 1 / 2	Mo to Su	6:00	22:00

Default program P2					
Heating circuit	Day	Heating operation			
		from	to	from	to
Boiler heating circuit	Mo to Th	6:00	8:00	16:00	22:00
	Fr	6:00	8:00	13:00	22:00
	Sa to Su	6:00	22:00		
Hot-water circuit	Mo to Th	5:00	8:00	15:30	22:00
	Fr	5:00	8:00	12:30	22:00
	Sa to Su	6:00	23:00		
Mixed heating circuit 1 / 2	Mo to Th	6:00	8:00	16:00	22:00
	Fr	6:00	8:00	13:00	22:00
	Sa to Su	7:00	23:00		

Default program P3			
Heating circuit	Day	Heating operation	
		from	to
Heat generator heating circuit	Mo to Fr	7:00	18:00
	Sa to Su	Reduced	
Hot-water circuit	Mo to Su	6:00	18:00
	Sa to Su	Reduced	
Mixed heating circuit 1 / 2	Mo to Su	7:00	18:00
	Sa to Su	Reduced	



#### 4.2.2.4.3.1 Copying switching time programs (days)



Block programming enables the switching times and cycle temperatures of any day of the week to be copied

- 1 – To any days within the week (Mo, Tu, We, ..., Su)
- 2 – To all weekdays (Mo to Fr)
- 3 – To the weekend (Sa to Su)
- 4 – To the entire week (Mo to Su)

#### Calling up the copy function (days)

See flowcharts on pg. 44

- Source day**
- ▶ Press input button  to confirm the copy function.
  - ▶ Turn input button  to select the source day (MO to SU) to be copied.  
The respective automatic program P1 (P2, P3) of the source day is copied in the display with the time switch symbol and the program index.

- Target day**
- ▶ Press input button  to confirm the source day.  
The source day appears flashing.
  - ▶ Turn input button  to select the following setting values and confirm by pressing the input button :
    - The following target days (Mo to Su) individually
    - All days of the week (1 to 7) as a week block
    - All weekdays (1 to 5) as a weekday block
    - The weekend days (6 to 7) as a weekend block

Acceptance is confirmed by acknowledging DAY COPY OK.

After acknowledgement, the following target days appear one after another automatically with each additional press of the input button  and can be skipped and accepted if necessary.

Pressing the  button causes an immediate return to the basic display.



**NOTE** Only complete days with all cycles and temperature specifications and the respective program can be copied.

#### 4.2.2.4.3.2 Copying switching time programs (heating circuits)

Block programming also enables the copying of all switching times and temperature specifications of a heating circuit to another heating circuit.

##### Calling up the copy function (heating circuits)

See flowcharts on pg. 44

- Source circuit**
- ▶ Press input button  to confirm the copy function.
  - ▶ Turn input button  to select the source circuit to be copied (HC, MC-1, MC-2, DHW).  
If automatic program P1, P2 or P3 (see "System Parameter" menu, PROGRAM parameter = P1 to P3) was enabled, the desired switching time program P1, P2 or P3 of the source circuit can be selected. If not enabled, program selection is skipped.

- Target circuit**
- ▶ Press input button , to confirm the source circuit.  
Based on the same chart, the desired target circuit and, if enabled, the desired program can be selected and accepted.

Acceptance is confirmed by acknowledging COPY OK. The copy function is then called up again to copy additional circuits, if necessary.

**NOTE** Heating circuits cannot be copied to hot-water circuits or the reverse due to the different temperature specifications. If a heating circuit (HC, MC-1, MC-2) is selected as the source circuit, the hot-water circuit (DHW) switches off as the target circuit.

A hot-water circuit as the source circuit is also the target circuit. In this case, only switching time programs P1 to P3 are copied among one another.

Pressing the  button causes an immediate return to the basic display.

### Block programming

The copy function enables a source day to be copied to any target days or to all days of the week (week programming). All cycles of the source day are copied. Individual heating cycles cannot be copied.

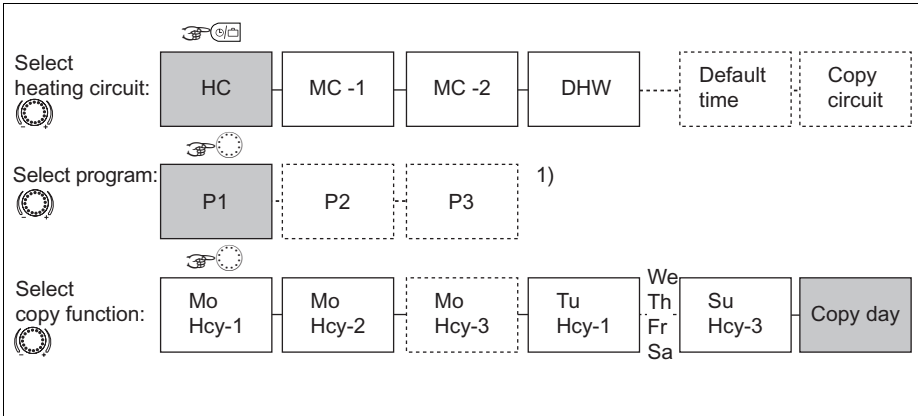

- HC Direct heating circuit
- MC-1 Mixed heating circuit 1
- MC-2 Mixed heating circuit 2
- DHW Hot-water heating circuit

1) Program selection for source and target circuits are skipped if programs P2 and P3 are disabled in the "System Parameter" menu.

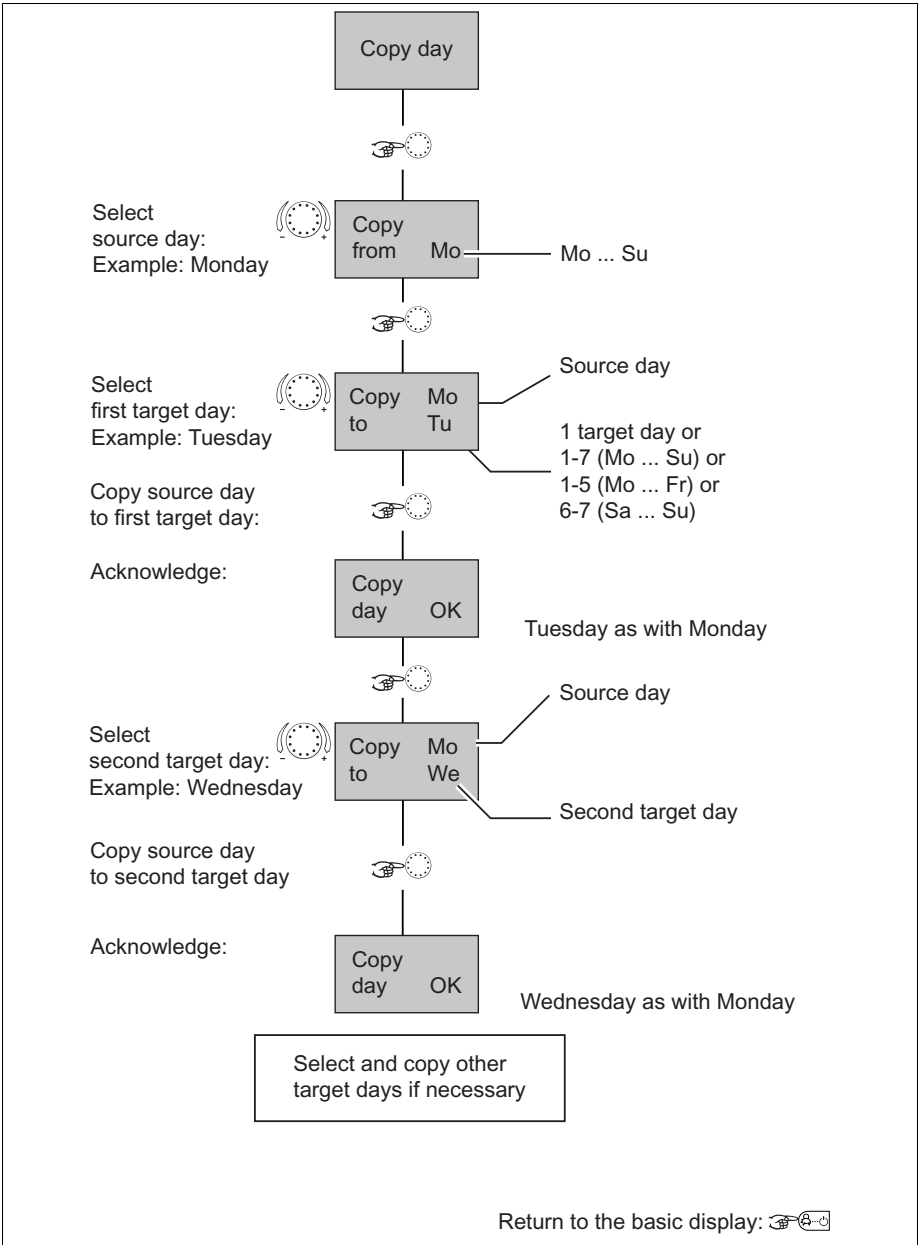

### Copying heating circuits

**NOTE** Heating circuits cannot be copied to hot-water circuits since they have different cycle temperatures: If a heating circuit is selected as the source circuit, the hot-water circuit can no longer be called up as the target circuit. The hot-water circuit as the source circuit is also the target circuit. In this case, only programs of the hot-water circuit are copied among one another if they were enabled in the "System Parameter" menu.

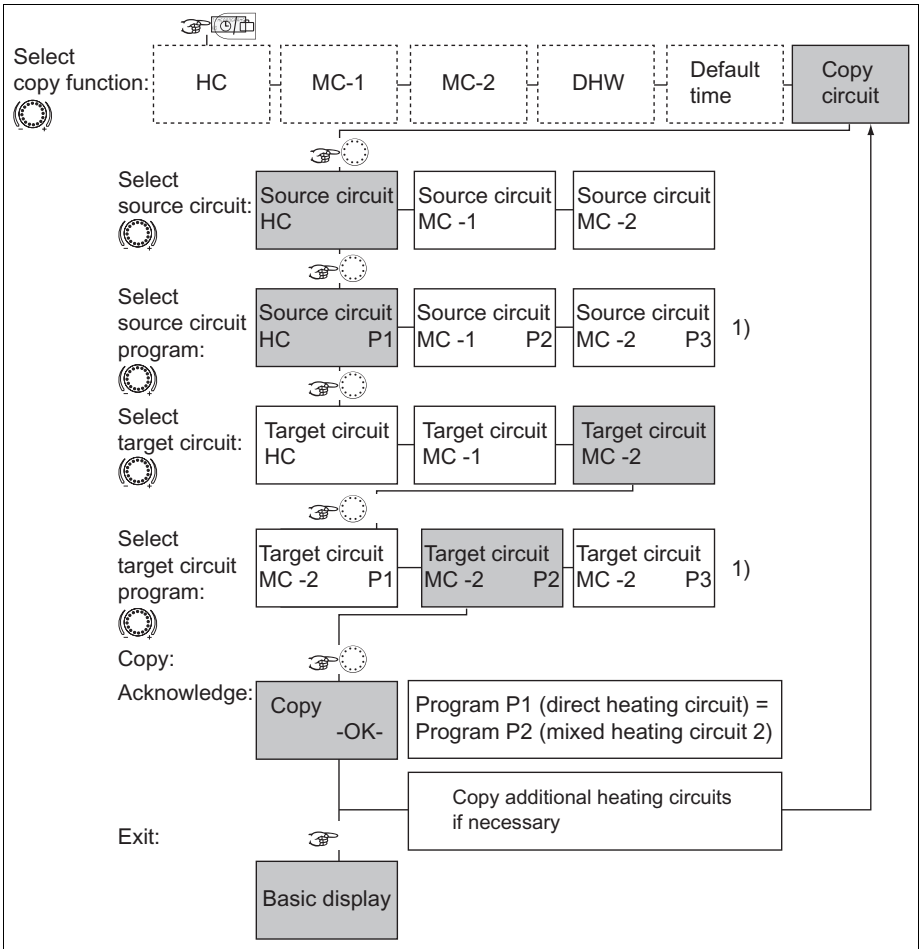

HC	Direct heating circuit
MC-1	Mixed heating circuit 1
MC-2	Mixed heating circuit 2
DHW	Hot-water heating circuit
1)	Program selection for source and target circuits are skipped if programs P2 and P3 are disabled in the "System Parameter" menu.

#### 4.2.2.4.4 Reloading default programs

See flowchart on pg. 49

Individually created switching time program P1, P2 or P3 can be overwritten with the original default switching time program P1, P2 or P3.

For this purpose, select the DEFAULT-TIME function within the heating circuit selection after accessing the "Timeprograms" menu.

After confirming by pressing the input button , the circuit dedicated to reloading appears flashing (HC, MC-1, MC-2, ALL).

If the automatic programs P1, P2 and P3 (see "System Parameter" menu, program parameter = P1 to P3) were enabled, the desired switching time program P1, P2 or P3 of the heating circuit affected by the reload can be selected. If not enabled, program selection is skipped.

**Resetting** Resetting then occurs by pressing and holding the input button approx. 5 s until acknowledgement appears in the display.

Resetting is confirmed by acknowledging COPY OK.

The DEFAULT-TIME function is then called up again to replace other circuits with their default programs if necessary.

**▲ ATTENTION**

**With the setting value ALL, all heating circuits and the hot-water circuit are overwritten with their default switching times with regard to the selected program.**

**When overwriting occurs, individually created switching time programs are permanently lost and must be recreated from scratch.**

Pressing the  button causes an immediate return to the basic display.



### Reloading default programs

Switching time programs P2 and P3 disabled

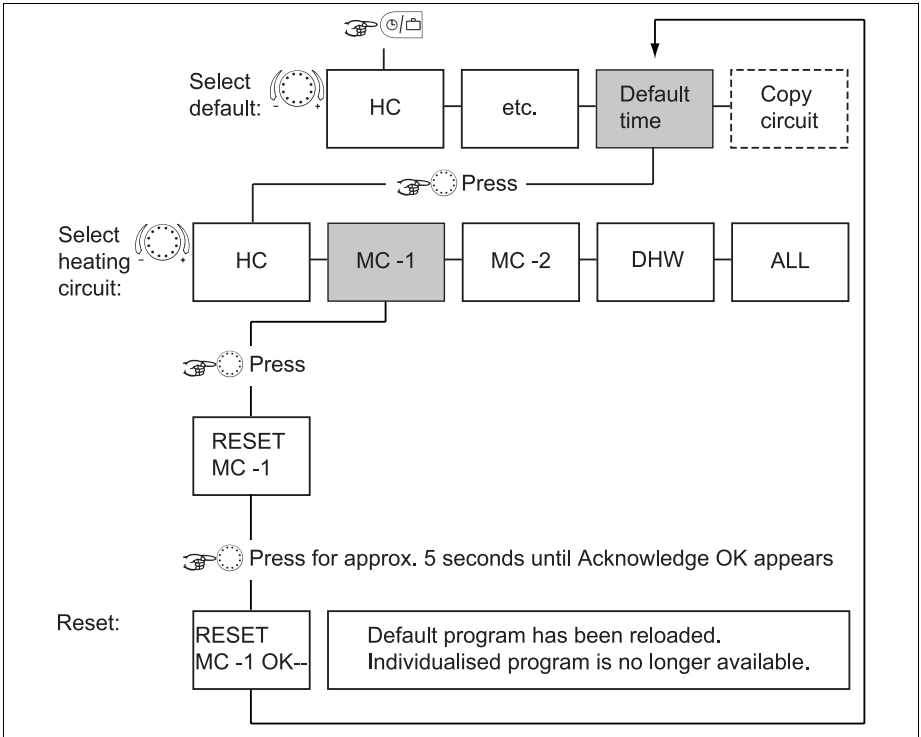

- HC Direct heating circuit
- MC-1 Mixed heating circuit 1
- MC-2 Mixed heating circuit 2
- DHW Hot-water heating circuit

### Reloading default programs

Switching time programs P2 and P3 enabled

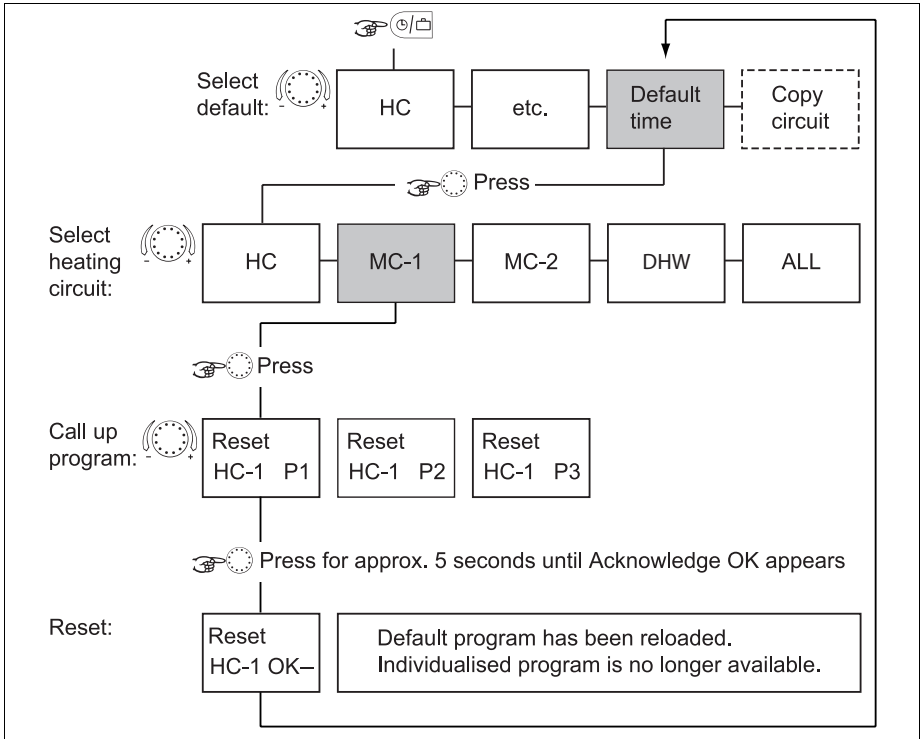

- HC Direct heating circuit
- MC-1 Mixed heating circuit 1
- MC-2 Mixed heating circuit 2
- DHW Hot-water heating circuit

### 4.2.3 "System Parameters" menu

The system parameters refer to general limiting parameters and specification values within the heating system.

**Access** See 4.2 Menu-selection level, pg. 31

**Returning** Returning to the basic display takes place by pressing the  button or automatically after the set information time (see 4.1.2.7 "System information" button, pg. 26).

#### 4.2.3.1 Language selection

Several languages can be selected for all information that appears in the display.

After selecting the language and confirming it by pressing the input button , additional communication takes place in the respective language.

<b>Setting values</b>	DE	German
	GB	English
	FR	French
	IT	Italian
	NL	Dutch
	ES	Spanish
	PT	Portuguese
	HU	Hungarian
	CZ	Czech
	PL	Polish
	RO	Romanian
	RU	Russian
	TR	Turkish
	S	Swedish
	N	Norwegian

**Factory setting** German

#### 4.2.3.2 Time program

This parameter specifies enabling of the switching time programs for program selection and for individualised switching time programming. In the state of delivery, only one switching time program is enabled. This achieves simplification of operation with a large portion of applications for which only one switching time program is used.

**Set values** P1 Program 1 = enabled, programs 2 and 3 = disabled  
 P1 All three programs enabled  
 to P3

**Factory setting** P1

**Effects** In contrast to the previous description, the following setting options are available when programs P1 to P3 are enabled:

- Operating mode selection: In the AUTOMATIC and SUMMER operating modes, switching time program P1, P2 or P3 can be selected.
- Switching time programming: With switching time programming, the three switching time programs, P1 to P3, can be selected for each heating circuit.

#### 4.2.3.3 Operating mode

Two operating modes can be selected. They determine whether the operating mode, the daytime temperature and the night-time temperature apply for all heating circuits or can be specified individually for each heating circuit.

**Setting range** 1, 2





**Set values** 1 The selected setting applies for all heating circuits together.  
 2 Each heating circuit can be assigned an individualised setting.

**Factory setting** 1

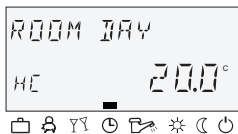
#### 4.2.3.3.1 Individualised daytime room temperature for each heating circuit

##### Setting



- ▶ Press  button.
- ▶ Select desired heating circuit (HC, MC-1 or MC-2) by turning the input button .
- ▶ Confirm selected circuit by pressing the input button .
- ▶ Set flashing room temperature specification to the desired value by turning the input button .
- ▶ Confirm set value by pressing the  button.

Alternative: Automatic acceptance of the value after the set information time (see 4.1.2.7 "System information" button, pg. 26).





**Setting range** 5 ... 30 °C

**Factory setting** 20 °C

#### 4.2.3.3.2 Individualised night-time room temperature for each heating circuit

##### Setting



- ▶ Press  button.
- ▶ Select desired heating circuit (HC, MC-1 or MC-2) by turning the input button .
- ▶ Confirm selected circuit by pressing the input button .
- ▶ Set flashing room temperature specification to the desired value by turning the input button .
- ▶ Confirm set value by pressing the  button.

Alternative: Automatic acceptance of the value after the set information time (see 4.1.2.7 "System information" button, pg. 26).

**Setting range** 5 ... 30 °C

**Factory setting** 16 °C

#### 4.2.3.3.3 Individualised operating mode for each heating circuit

Each heating circuit can be assigned an individualised operating mode.

##### Setting



- ▶ Press button.
- ▶ Select desired heating circuit (HC, MC-1 or MC-2) by turning the input button .
- ▶ Confirm selected circuit by pressing the input button .
- ▶ Select flashing operating mode by turning the input button .
- ▶ Confirm set operating mode by pressing the button or the input button .
- ▶ With short-term operating modes (ABSENT, PARTY), set desired target value by turning the input button and confirm set value by pressing the input button .

Alternative: Automatic acceptance of the value after the set information time (see 4.1.2.7 "System information" button, pg. 26).

#### 4.2.3.4 Summer / Heating limit

This parameter specifies the end of heating operation depending on the outside temperature based on the following criteria:

##### Quick increase in outside temperature

If the averaged outside temperature is below the set value and the current outside temperature is 2 K above the set value, heating operation is interrupted.

##### Slow increase in outside temperature

Deactivation is also initiated when the averaged and current outside temperature exceeds the set value.

### Undoing deactivation

Deactivation is undone when the averaged **and** current outside temperature exceeds the set value by 1 K.

The summer deactivation function is undone:

- In case of an outside sensor defect
- In case frost protection is active

**NOTE** During deactivation phases (standby mode, manual summer operation, summer deactivation) lasting longer than 24 hours all pumps are switched on for approx. 20 s and the mixers are temporarily opened during this time to protect against blocking by corrosion.

In connection with a second outside sensor, the current averaged outside temperature is accepted for summer deactivation if the average value of both sensors is specified during outside sensor assignment.

Active summer deactivation is represented by a beach umbrella symbol in the basic display.

Only active in the AUTOMATIC operating mode.

**Factory setting** 20 °C



**Setting range** OFF, set value of system frost protection to 40 °C

#### 4.2.3.5 Parameter reset

With the reset parameter, it is possible to reset any inadvertently made changes in the parameter menu to the factory setting.

#### ATTENTION

**A reset should only be carried out if all individually entered values are to be replaced by the values specified at the factory.**

- Setting**
- ▶ When the PARAM. RESET display flashes, press the input button . SET flashes in the display.
  - ▶ Press and hold the input button  for 5 s.

If a reset is carried out, the RESET OK confirmation appears briefly. Verification is then started with a call-up of the first parameter in the respective menu once again.

After the parameter values are reset, a return to the first parameter in the "System Parameter" menu occurs.

#### 4.2.4 "DHW" menu

This menu contains all parameters required to program the hot-water circuit, except the hot-water switching time programs.

##### 4.2.4.1 Night-time hot-water temperature

This parameter specifies the temperature in the hot-water generator between the operational-readiness times in automatic mode.

**Factory setting** 40 °C

**Setting range** 5 °C to set normal hot-water temperature value

**NOTE** If a hot-water thermostat (see parameter 05 = transducer for hot-water circuit) is used to detect the hot-water temperature, this parameter is skipped.

##### 4.2.4.2 Legionella protection day

**Factory setting** OFF

**Setting range** OFF, MO to SU, ALL

<b>Set values</b>	OFF	The legionella protection function is not active.
	MO to SU	Legionella protection is activated on the selected day of the week at the legionella protection time set in the following parameter.
	ALL	The legionella protection function is activated daily at the legionella protection time set in the next parameter.



**NOTE** If a hot-water thermostat (see 05 parameter = transducer for hot-water circuit) is used to detect the hot-water temperature, these parameters are skipped.

#### 4.2.5 "Direct Heating Circuit" / "Mixed Heating Circuit 1" / "Mixed Heating Circuit 2" menu

These menus contain all parameters required to program the heating circuit, except the switch time programs. Max. one direct heating circuit and two mixed heating circuits (mixed heating circuit 1 and mixed heating circuit 2) are available as heating circuits.

The following described heating circuit parameters are available separately for setting for each heating circuit.

##### 4.2.5.1 Reduced operation

During reduced operation, you can select between two operating modes.

**Factory setting** ECO

**Setting range** ECO, RED

##### **Set values RED (lowering operation)**

The heating circuit pump of the direct heating circuit continues functioning during reduced operation (see 4.2.3.2 Time program, pg. 52). The flow temperature is determined based on the lowered room temperature from the associated reduced heating curve. The set maximum temperature is not undershot.

**Application** Building with minimal insulation values and high cooling loss.

**ECO (switch-off operation)**

During reduced operation, the direct heating circuit is switched off completely with outside temperatures above the set frost-protection limit. The maximum heat generator temperature is not functional. The heating circuit pump is switched off after a delay to avoid safety deactivation by reheating the heat generator (pump follow-up).

If the outside temperature is or becomes lower than the specified outside temperature frost-protection limit, the controller switches from deactivated (deactivation mode) to lowered lowering operation and controls the heating circuit temperature based on the set lowering curve taking the set minimum heat generator specification into account.

**Application** Building with high insulation values (full heating protection).

**NOTE** The mode set here also applies for the ABSENT and RED. HEATING operating modes.

**4.2.5.2 Heating system**

This parameter refers to the type of the heating system (floor, radiator or convector heating) and can be matched to the exponent of the respective heat distributor. Using its progressive characteristics, the set value determines the curve characteristics of the heating curve of the direct heating circuit and compensates for the losses in output in the low-temperature range with it.

The following settings are recommend depending on the type of heating system:

- 1,1 Slightly progressive heating curves for floor or other area heating.
- 1,3 Progressive standard heating curves for all radiator heating with m-values between 1.25 and 1.35.
- 2 Progressive heating curves for convector and baseboard heating.
- >3 Heavily progressive heating curves for general ventilator applications with high starting temperatures.

<b>Factory setting</b>	1,3	(radiator systems)
	1,1	(floor heating) with mixed heating circuits
<b>Setting range</b>	1 ... 10	

### 4.3 Error messages

#### ATTENTION

**Inform the heating technician whenever any fault messages are output.**

The control device contains substantial error-notification logic. The error messages appear in continuous alteration with the basic display. Multiple errors that occur at the same time appear one after another in the order in which they occurred. The following types of error message exist:

<b>Sensor error messages</b>	Sensor measured values that do not lie in the measurement range are evaluated as an interruption or short-circuit. They appear depending on the type and allocation with fault code 10 to 20 and index 0 for interruption or 1 for short-circuit.
<b>Heat generator error messages</b>	These error messages evaluate the respective switching status. They appear depending on the type and allocation with fault code 30 to 40 and index 0, 1 or 2.
<b>Logical error messages</b>	These error messages evaluate the control result to be expected. They appear depending on the type and allocation with fault code 50 to 60 and index 0, 1 or 2.
<b>Bus error messages</b>	These error messages refer to address faults such as double issuance or non-recognition of address settings on the data bus. They appear with fault code 70 and index 0 or 1, depending on the type and assignment.

### 5 Log

#### Weekly switching program

Object:		Set by:					On:		
Mon (1)	Cont. circuit								
	Time								
	Setpoint								
	Opt.								
Tue (2)	Cont. circuit								
	Time								
	Setpoint								
	Opt.								
Wed (3)	Cont. circuit								
	Time								
	Setpoint								
	Opt.								
Thu (4)	Cont. circuit								
	Time								
	Setpoint								
	Opt.								
Fri (5)	Cont. circuit								
	Time								
	Setpoint								
	Opt.								
Sat (6)	Cont. circuit								
	Time								
	Setpoint								
	Opt.								
Sun (7)	Cont. circuit								
	Time								
	Setpoint								
	Opt.								







# Honeywell

Manufactured for and on behalf of the Environmental and Combustion Controls Division of Honeywell Technologies Sàrl, Rolle, Z.A. La Pièce 16, Switzerland by its Authorized Representative:

## **Automation and Control Solutions**

Honeywell House  
Arlington Business Park  
Bracknell, Berks, RG12 1EB  
Phone(44) 1344 656000  
Fax (44) 1344 656644  
<http://honeywell.com/uk>

 **AutomatikCentret**

Strandvejen 42 ♦ Saksild ♦ 8300 Odder  
86 62 63 64 ♦ [www.automatikcentret.dk](http://www.automatikcentret.dk)  
[info@automatikcentret.dk](mailto:info@automatikcentret.dk)

Printed in Germany  
All rights reserved. Subject to change without notice.

EN2H-0220GE51 R1111  
Art. 045 130 5546 – 1148 – 31