



Braukmann V1810

Alwa-Kombi-4 Circulation throttle valve

APPLICATION

The Alwa-Kombi-4 is used as throttle valve for hydronic balancing of warm potable water circulation systems.

To achieve a hydronic balance the flow in the circulation pipe is throttled by manually presetting the valve. The valve can also be equipped with a thermal actuator which allows a regulation of the water temperature in the circulation system to the exact degree. The thermal actuator can be installed without interruption of the warm water supply.

When the thermal actuator 50 - 60 °C (122 - 140 °F) is used, a thermal disinfection according to DVGW worksheet W551 and W553 is supported. Hydronic balance is also retained during the thermal disinfection process to ensure disinfection of all pipelines and risers.

APPROVALS

- DVGW
- WRAS

SPECIAL FEATURES

- Meets KTW requirements
- For regulation according to DVGW worksheets W551 and W553
- Valve housing and all parts with flow-contact made of corrosion-resistant, dezincification-resistant brass
- Retrofittable automatic temperature-control with support of thermal disinfection
- Draining option with retrofittable and removable draining adapter
- No additional side connections to valve housing
- Cavity-free cartridge with maintenance-free spindle sealing
- Spindle thread is isolated from the flow
- Seat sealing made of PTFE
- Visible, digital presetting dial with concealed presetting handwheel
- High accuracy due to factory calibration to every single valve

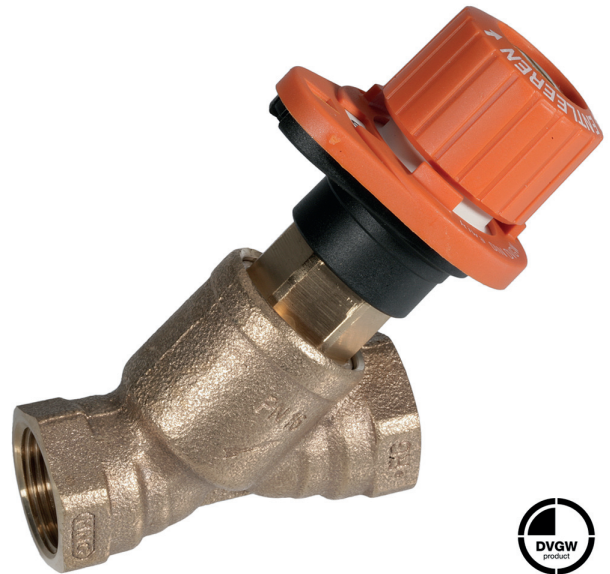

TECHNICAL DATA

Media	
Medium:	Drinking water
Pressure values	
Max. operating pressure:	16 bar (232 p.s.i.)
Operating temperatures	
Max. operating temperature medium:	130 °C (266 °F) WRAS approval up to 85 °C (185 °F)

CONSTRUCTION

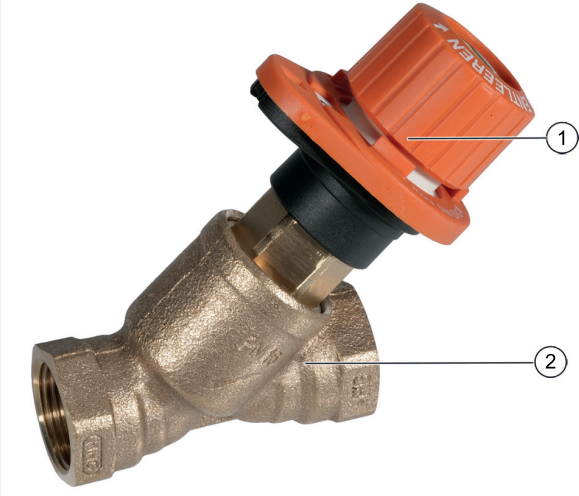
Overview	Components	Materials	
	1	Handwheel with digital display of presetting	Presetting dial and display made of plastic, orange
	2	Valve housing in straight pattern with internal threads to DIN EN 10226-1 or external threads according to DIN ISO 228	Dezincification-resistant brass
Not depicted components:			
	Valve insert	Red bronze and brass	
	O - rings	EPDM	
	Regulating cone	Red bronze/stainless steel	
	Seat sealing	PTFE	

METHOD OF OPERATION

As throttle valve the Alwa-Kombi-4 limits the flow through the circulation pipe. This is achieved either by manually closing the valve to a certain position or automatically, when the valve is equipped with a thermal actuator.

Manual presetting: the valve is preset according to a calculated value and stays in that position. The flow of the water is limited by the narrowed valve opening.

Automatic regulation: the valve is equipped with a thermal actuator and preset to the desired water temperature. The thermal actuator holds the water temperature at the valve to the exact degree.

When the water temperature falls the valve opens and the flow of warm water increases. When the water temperature rises, the valve closes and shuts-off when the preset water temperature is reached (except for a leakage rate).

With manual presetting the valve can only be set for optimal operation under „full load“. The automatic regulation process allows a permanent regulation and by that an optimal supply of all pipelines under most economical energy use.

As part of Resideo's "Kombi" family of valves, additional functions can also be fitted and used after the valve has been installed. The functions are carried out by installing adapters into the cartridge spindle:

- The thermal actuator (preferably 50 - 60 °C [122 - 140 °F]) can be installed at any time without interrupting the supply of warm water. The actuator is simply screwed into the spindle and allows permanent hydronic balancing based on the water temperature in the circulation pipe
- The draining adapter is fitted to drain a pipe or riser and can be removed when the draining process is finished. It can be used with any Alwa-Kombi-4 potable water balancing valve and also any Resideo Kombi-3-plus heating/cooling balancing valve
- The sampling valve is used in conjunction with the drain adapter and is used to determine chemical and microbiological parameters

Thermal disinfection at temperature over 70°C (158°F)

Supported by Alwa-Kombi-4 with fitted thermal actuator 50 - 60 °C (122 - 140 °F) Starting from the leakage rate the valve opens at a water temperature of 63 °C (145 °F) and the flow rate increases.

When the water reaches a temperature of 72 °C (162 °F) the flow of the water is throttled to a flow rate below the leakage rate. This has the advantage that the hydronic balance is retained and the hot water is repily distributed in all risers and pipelines.

When the thermal disinfection process is finished and the water temperature drops again, Alwa-Kombi-4 returns to the standard control position.

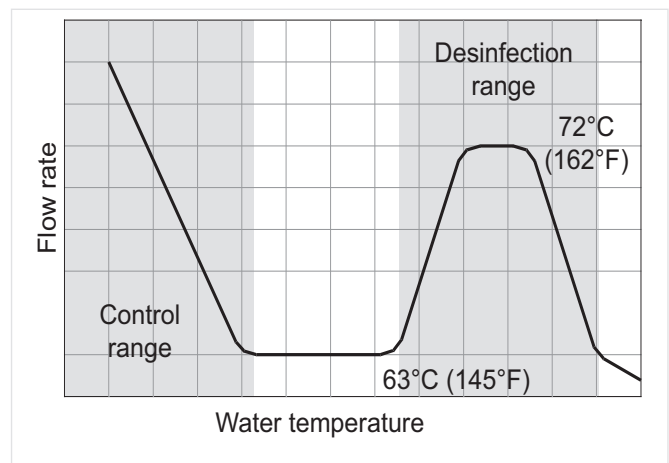

Fig. 1 Relation of flow rate and water temperature

Note: The thermal disinfection is only supported by the thermal actuator 50 - 60 °C (122 - 140°F), OS - No. VA2400A002. The thermal actuator has to be set to 55°C (131°F) = presetting 1.5.

TRANSPORTATION AND STORAGE

Keep parts in their original packaging and unpack them shortly before use.

The following parameters apply during transportation and storage:

Parameter	Value
Environment:	clean, dry and dust free

INSTALLATION EXAMPLE

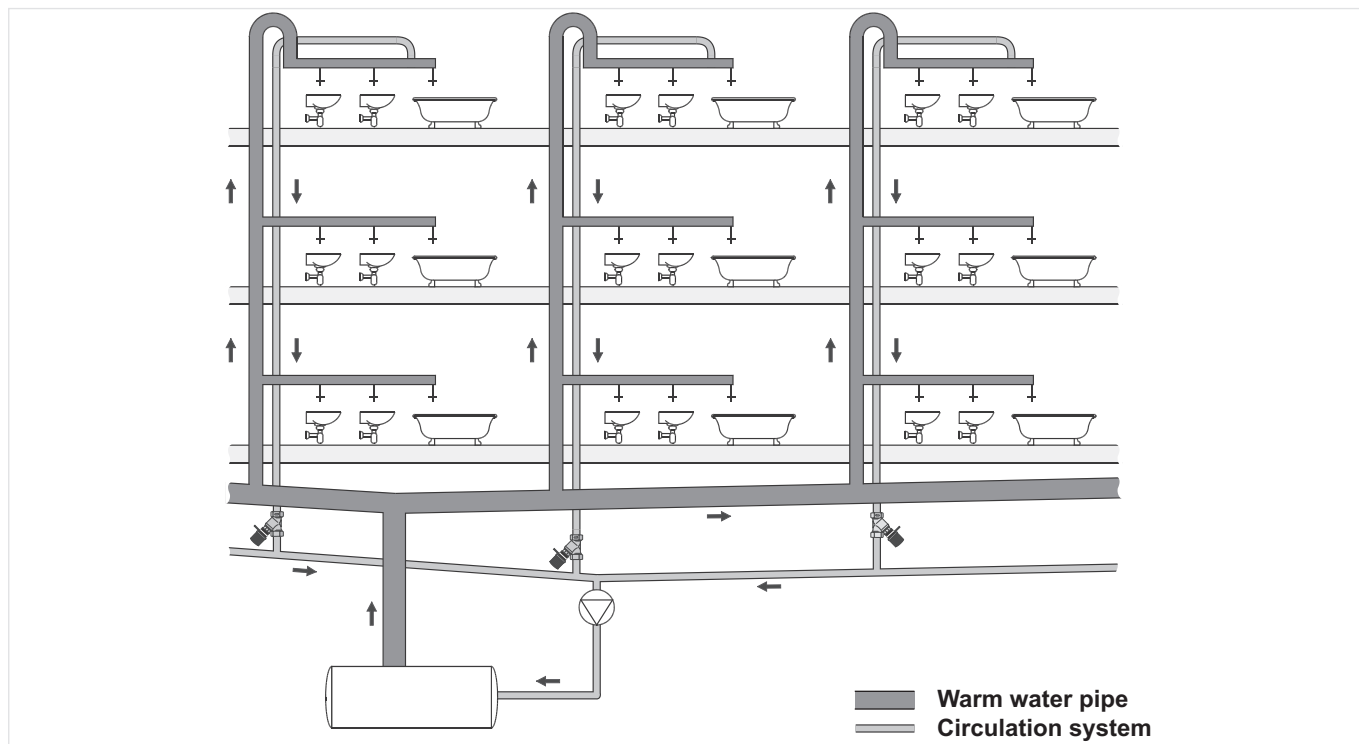

Fig. 2 Standard installation example for the control valve

TECHNICAL CHARACTERISTICS

kvs-Values

Alwa-Kombi-4 with internal and external threads

Connection sizes:	15	20	25	32	40
k_{VS} -value (m^3/h):	2.7	6.4	6.8	16.0	16.0

V1810 Flow Data, DN15

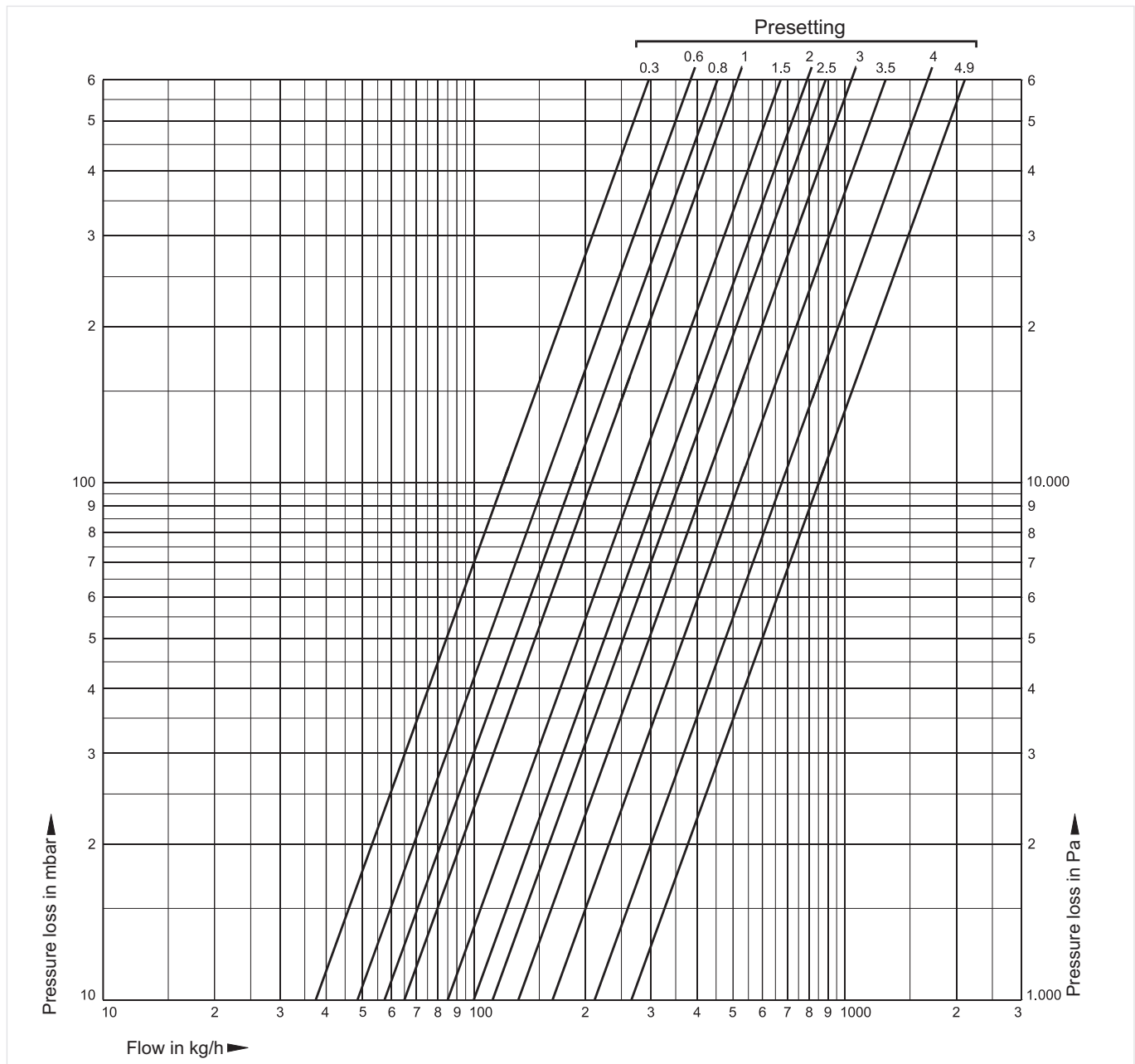

Presetting:	0.3	0.6	0.8	1.0	1.5	2.0	2.5	3.0	3.5	4.0	4.9 = open
k_{VS} -value:	0.37	0.49	0.57	0.65	0.85	1.00	1.13	1.32	1.66	2.12	$k_{VS} = 2.70$

Note: Due to manufacturing reasons the closes position (shut-off) is already reached between presetting 0.2 and 0.4.

Flow Data for DN20

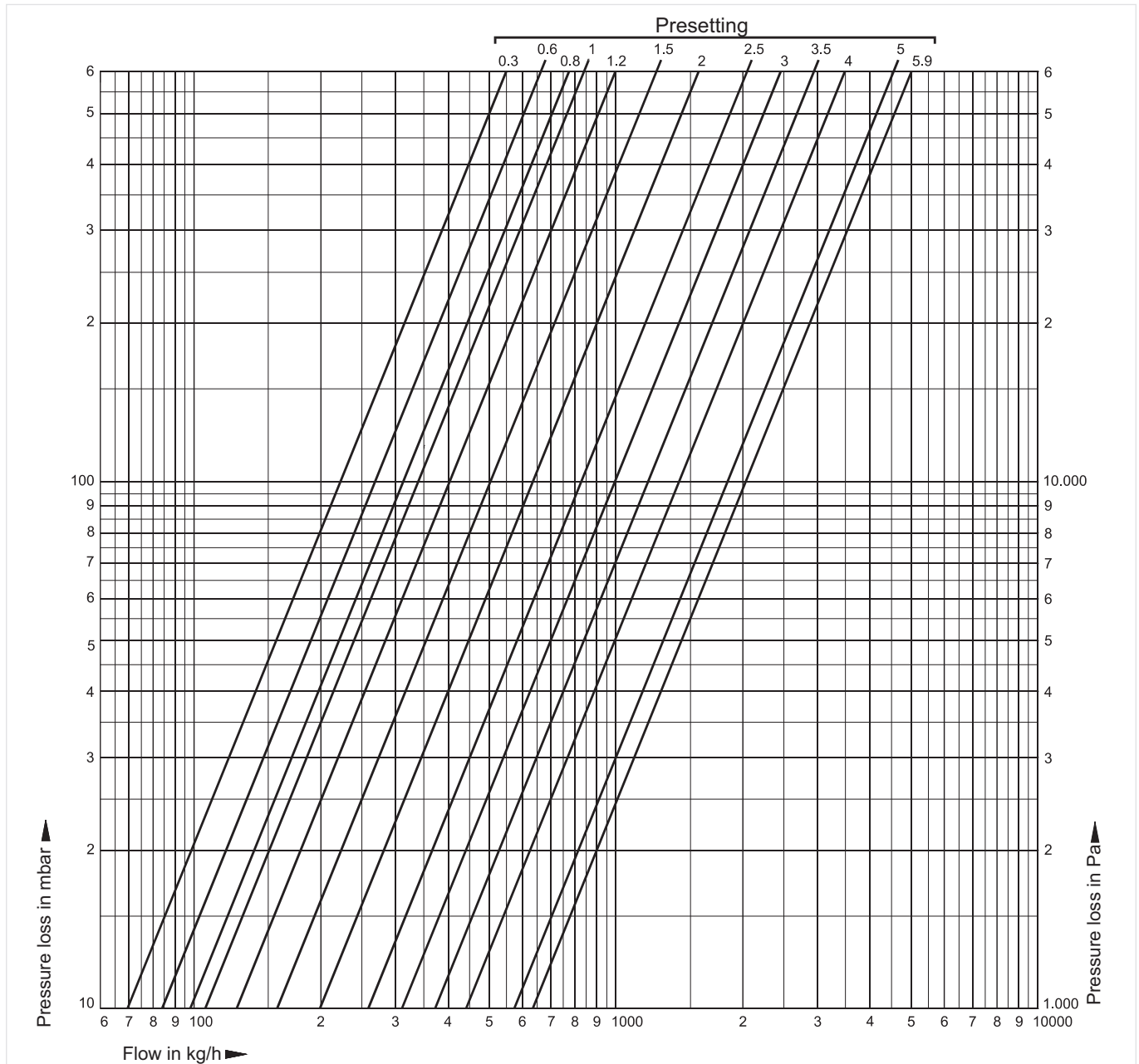

Presetting:	0.3	0.6	0.8	1.0	1.2	1.5	2.0	2.5	3.0	3.5	4.0	5.0	5.9 = open
k_{VS} -value:	0.68	0.84	0.97	1.10	1.30	1.60	2.10	2.60	3.12	3.73	4.40	5.84	$k_{VS} = 6.40$

Note: Due to manufacturing reasons the closes position (shut-off) is already reached between presetting 0.2 and 0.4.

Flow Data for DN25

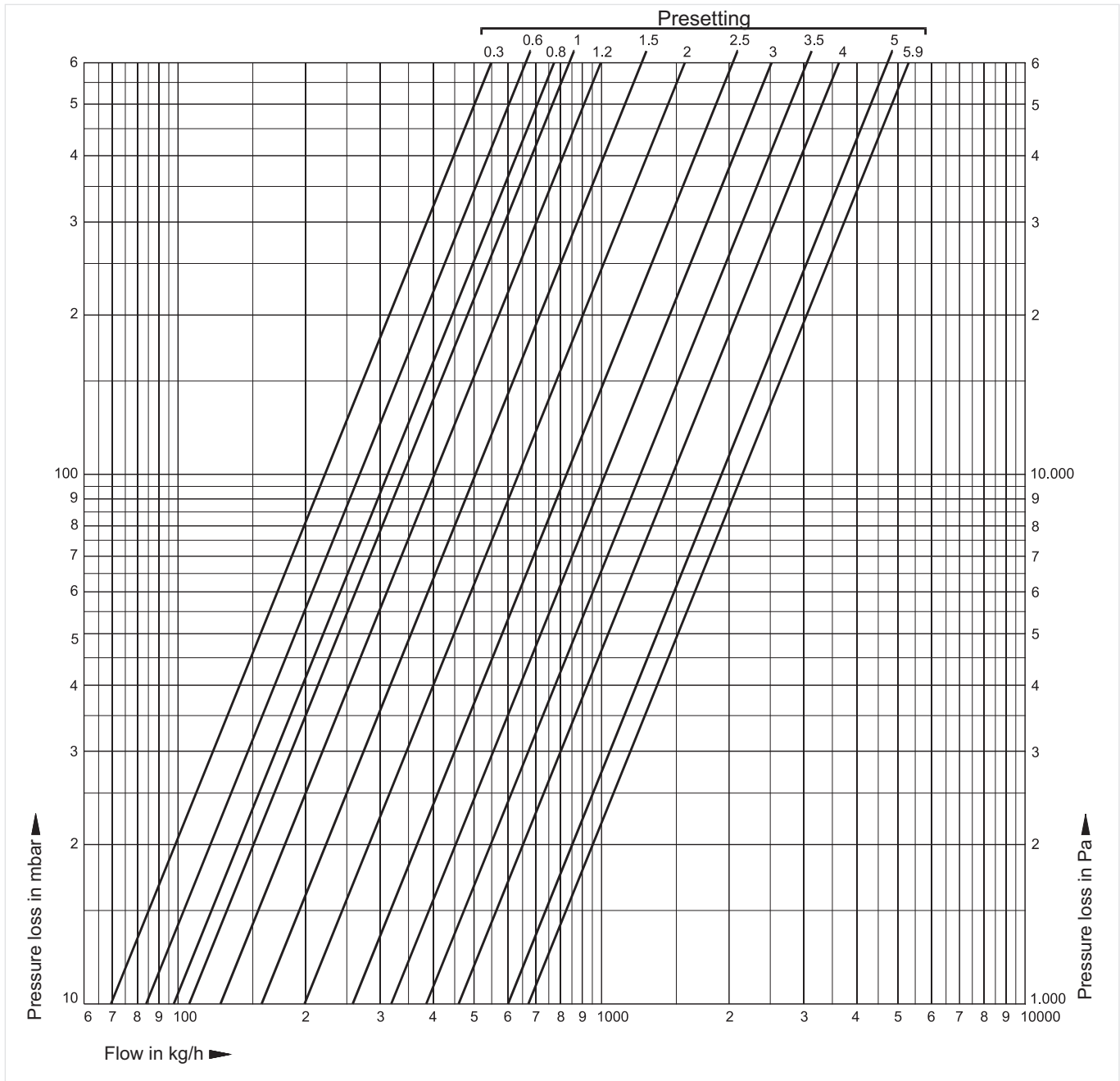

Presetting:	0.3	0.6	0.8	1.0	1.2	1.5	2.0	2.5	3.0	3.5	4.0	5.0	5.9 = open
k_{VS} -value:	0.68	0.84	0.97	1.10	1.30	1.60	2.10	2.60	3.20	3.90	4.64	6.06	$k_{VS} = 6.80$

Note: Due to manufacturing reasons the closes position (shut-off) is already reached between presetting 0.2 and 0.4.

Flow Data for DN32 and DN40

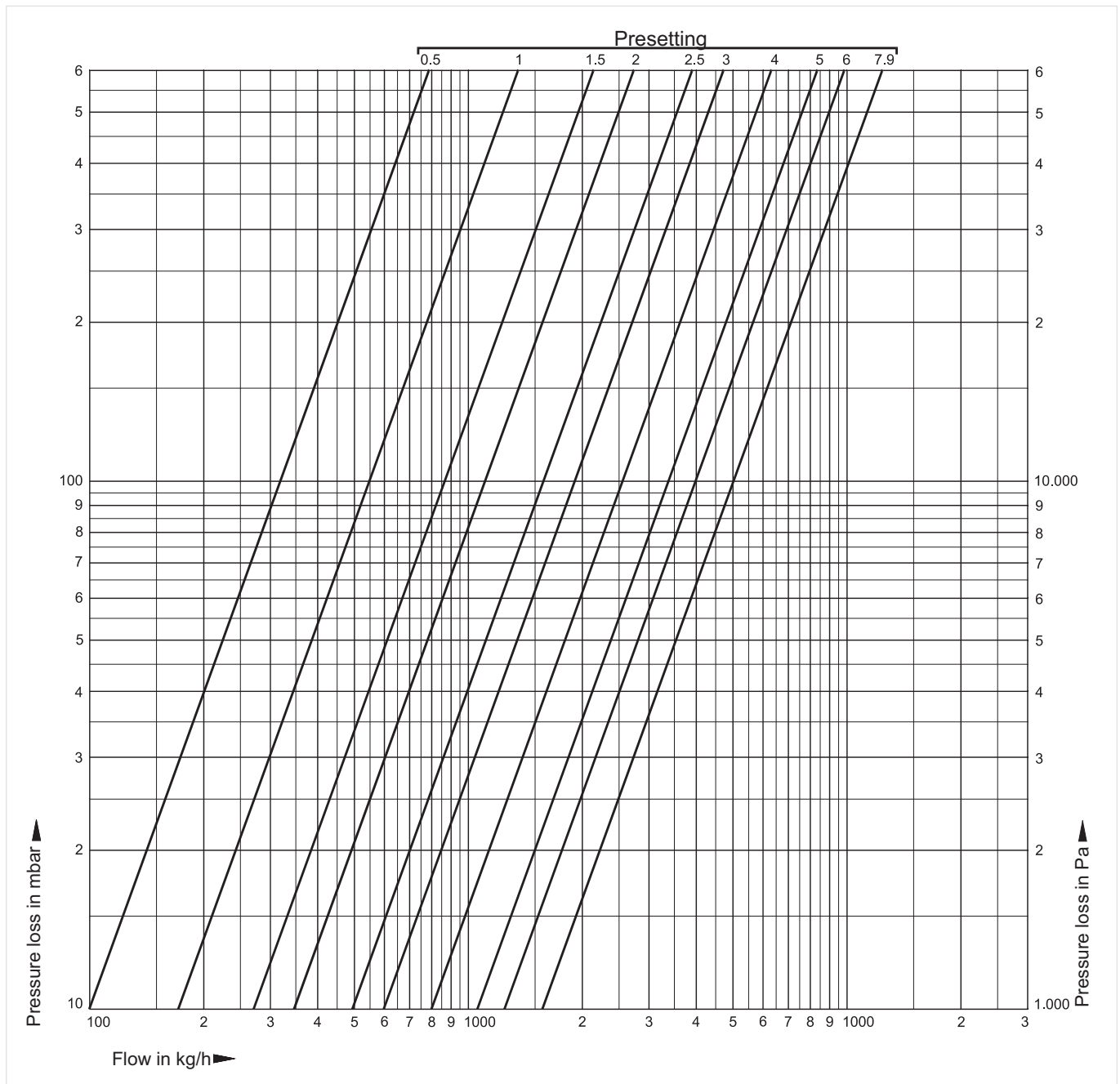

Presetting:	0.5	0.6	0.7	0.8	1.0	1.4	1.6	1.8	2.0	2.2	2.4	2.6	2.8
k_{VS} -value:	1.02	1.13	1.42	1.48	1.70	2.16	2.44	2.96	3.54	4.12	4.71	5.28	5.77
Presetting:	3.0	3.2	3.4	3.6	3.8	4.0	4.2	4.4	4.6	4.8	5.0	5.2	5.4
k_{VS} -value:	6.13	6.44	6.91	7.77	8.19	8.74	9.20	9.36	9.62	10.10	10.5	11.0	11.5
Presetting:	5.8	6.0	6.2	6.4	6.6	6.8	7.0	7.2	7.4	7.6	7.8	7.9 = open	
k_{VS} -value:	12.0	12.5	12.8	13.3	13.7	14.1	14.5	14.8	15.0	15.3	15.6	$k_{VS} = 16.0$	

Note: Due to manufacturing reasons the closes position (shut-off) is already reached between presetting 0.2 and 0.4.

Alwa-Kombi-4 with installed thermal actuator
kv_v-value of Alwa-Kombi-4 with installed thermal actuator 50 - 60 °C (122 - 140 °F) in relation to water temperature at presetting 1.5

DN15

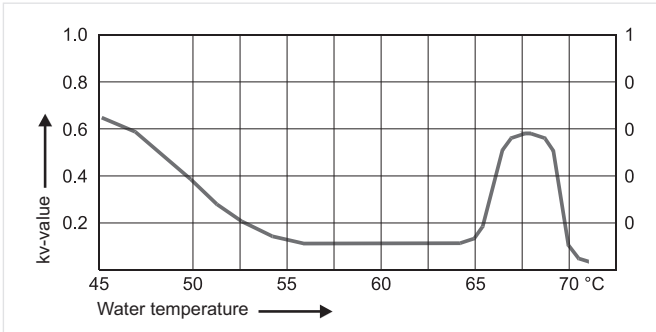

DN20 and DN25

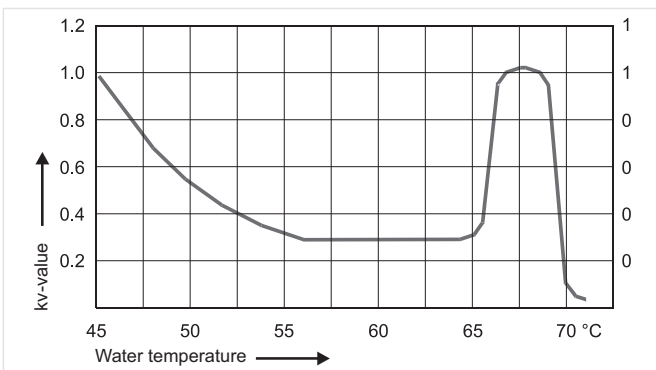

DN32 and DN40

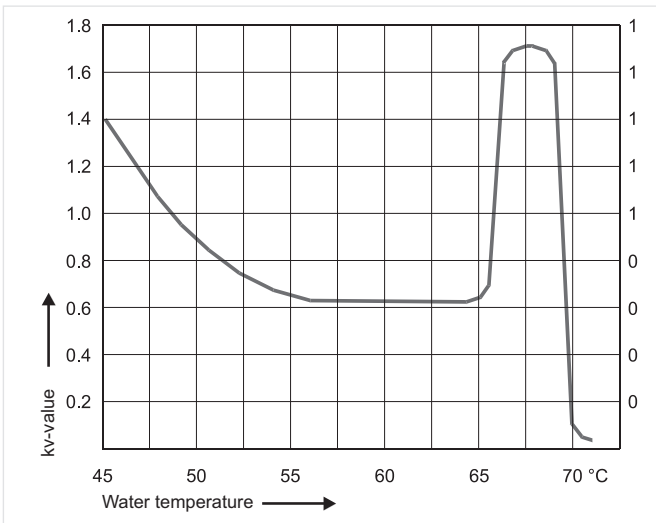

Presetting values for thermal actuators

We recommend: Presetting value = desired minimal temperature (standard setting). Desired minimal temperature 55 °C (131 °F) = Presetting 1.5

If the required throttle position according to DVGW worksheet W553 is to the right of the 2K-line (temperature in pipe is below 53°C [127°F] at presetting 1.5) the presetting has to be increased by 2K:

Desired minimal temperature 55 °C (131 °F) + 2K = Presetting 1.7

If the required throttle position according to W553 is to the right of the 5K-line (temperature in pipe is below 53 °C [127 °F] at presetting 1.7) the following possibilities are left:

- Manually preset thermal actuator and valve with values calculated according to DVGW worksheet W553
- Use valve of larger dimension
- Increase presetting by 5K: 55 °C (131 °F) + 5K = presetting 2.0 The increased pressure loss over the valve must be taken into account when the pump is specified!

When installation is set according to above recommendations the hydronic balance is also retained at 70 °C (158 °F) during the thermal disinfection process.

Flow Data for DN15 with thermal actuator 50 - 60 °C

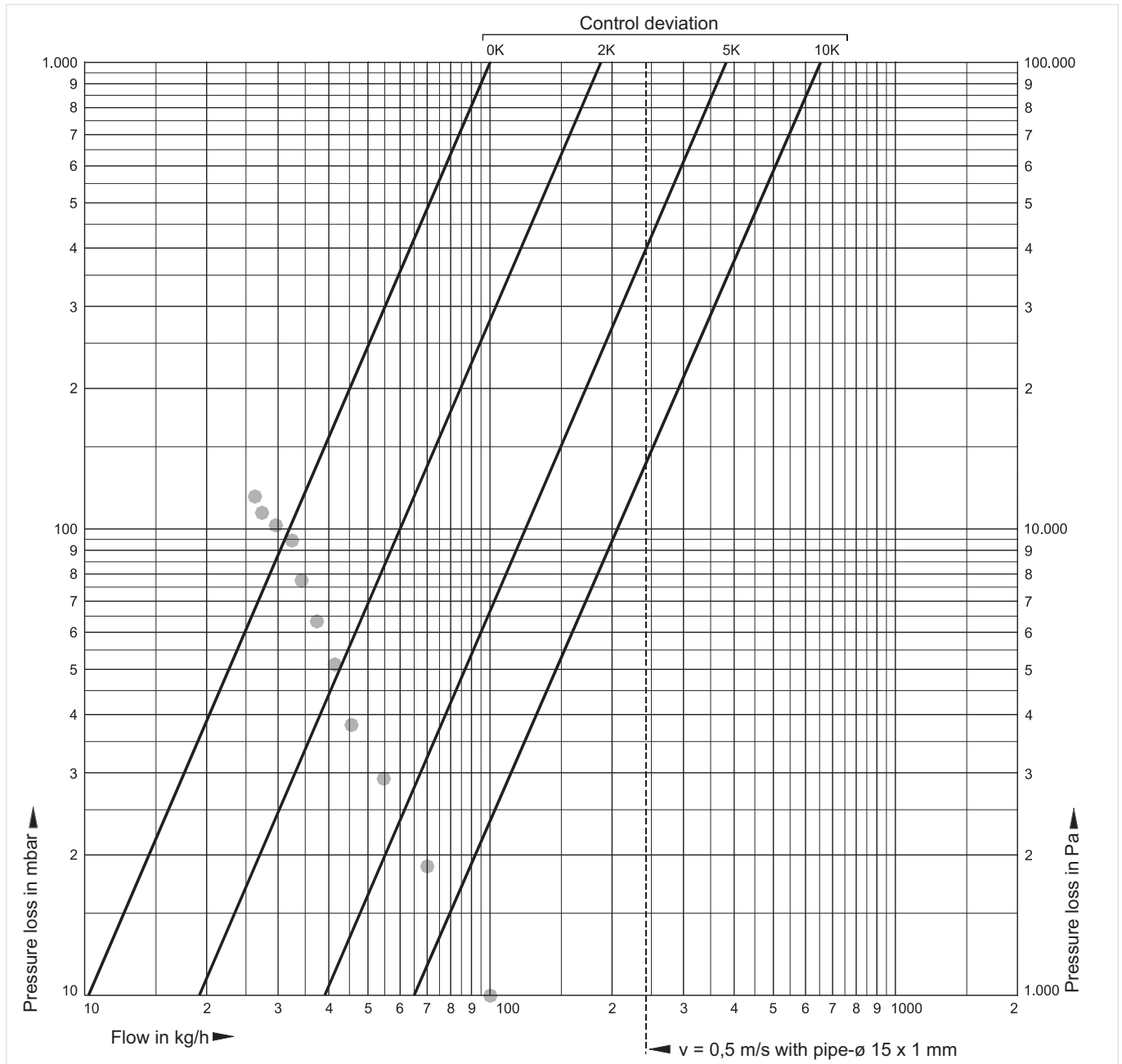

- Throttle position according to calculation example 3 of DVGW worksheet W553 (multi storey building with 48 flats)

Presetting:	1.0	1.1	1.2	1.3	1.4	1.5	1.6	1.7	1.8	1.9	2.0
k_{VS} -value:	50	51	52	53	54	55	56	57	58	59	60

Note: Due to manufacturing reasons the closes position (shut-off) is already reached between presetting 0.2 and 0.4.

Flow Data for DN20 and DN25 with thermal actuator 50 - 60°C

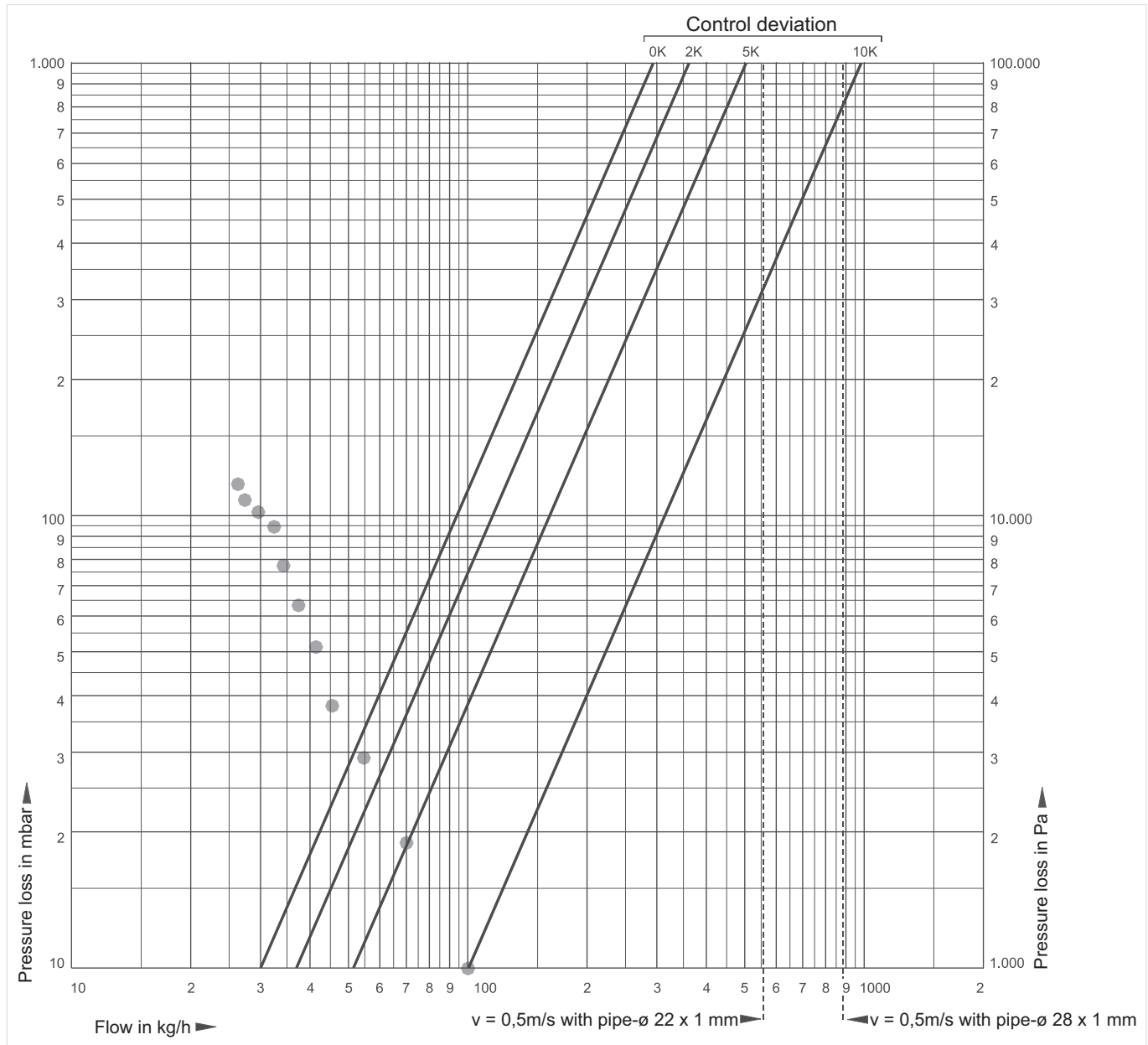

- Throttle position according to calculation example 3 of DVGW worksheet W553 (multi storey building with 48 flats)

Presetting:	1.0	1.1	1.2	1.3	1.4	1.5	1.6	1.7	1.8	1.9	2.0
k_{VS} -value:	50	51	52	53	54	55	56	57	58	59	60

Note: Due to manufacturing reasons the closes position (shut-off) is already reached between presetting 0.2 and 0.4.

Flow Data for DN32 and DN40 with thermal actuator 50 - 60°C

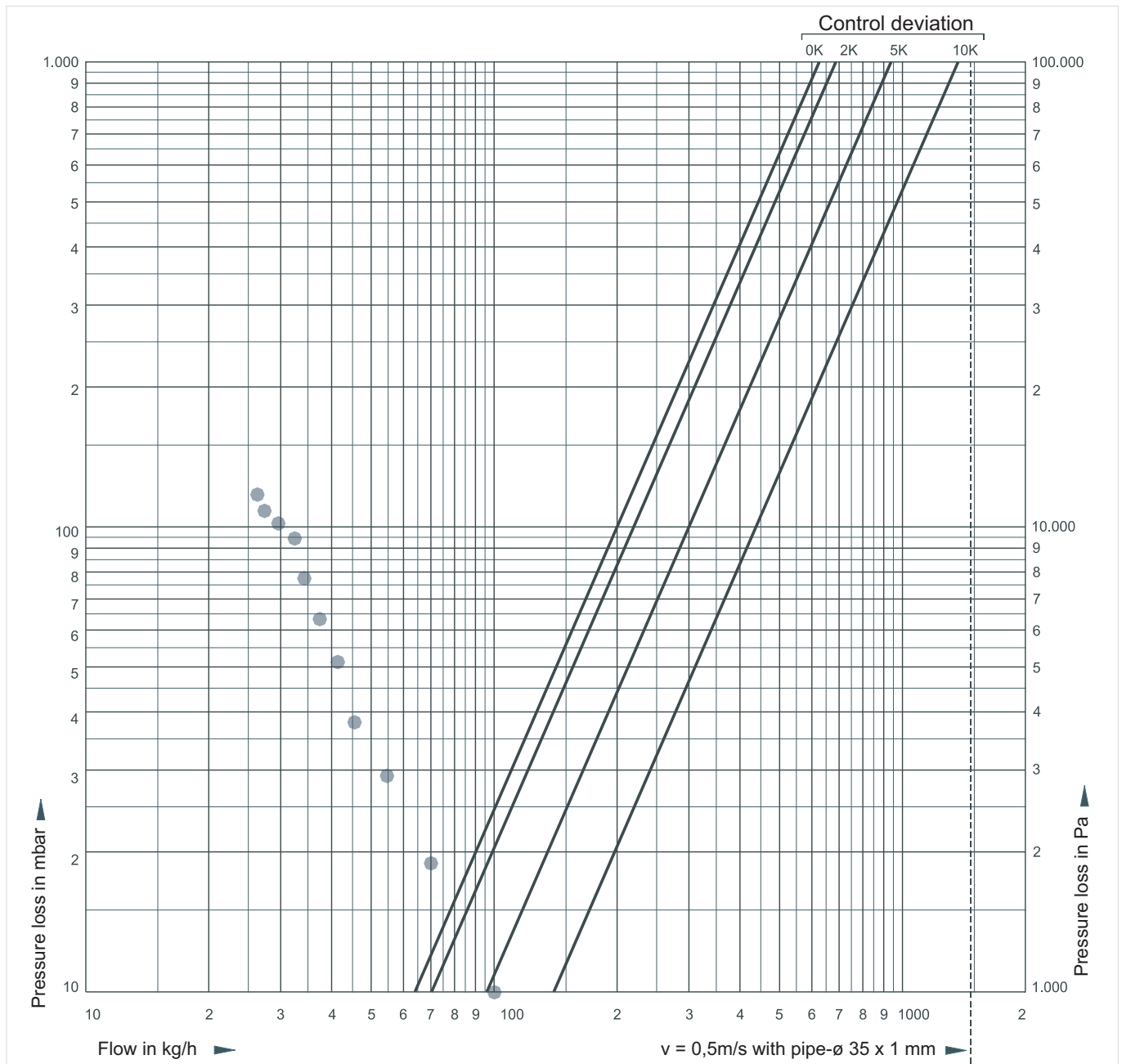

- Throttle position according to calculation example 3 of DVGW worksheet W553 (multi storey building with 48 flats)

Presetting:	1.0	1.1	1.2	1.3	1.4	1.5	1.6	1.7	1.8	1.9	2.0
k_{VS} -value:	50	51	52	53	54	55	56	57	58	59	60

Note: Due to manufacturing reasons the closes position (shut-off) is already reached between presetting 0.2 and 0.4.

Flow Data for DN15 with thermal actuator 40 - 65°C

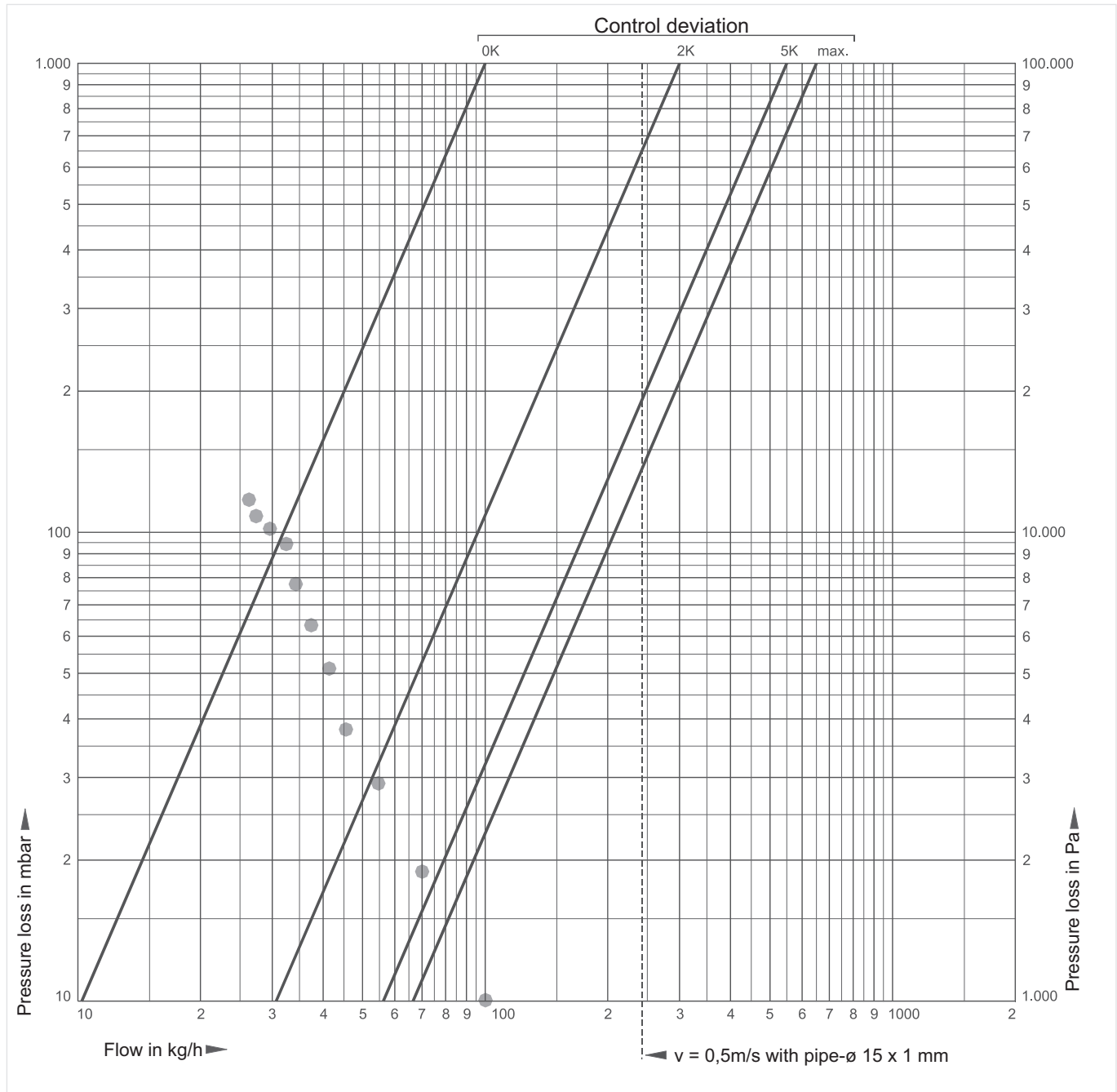

- Throttle position according to calculation example 3 of DVGW worksheet W553 (multi storey building with 48 flats)

Presetting:	0.5	0.7	1.0	1.2	1.5	2.0
k_{VS} -value:	40	45	50	55	60	65

Note: Due to manufacturing reasons the closes position (shut-off) is already reached between presetting 0.2 and 0.4.

Flow Data for DN20 and DN25 with thermal actuator 40 - 65°C

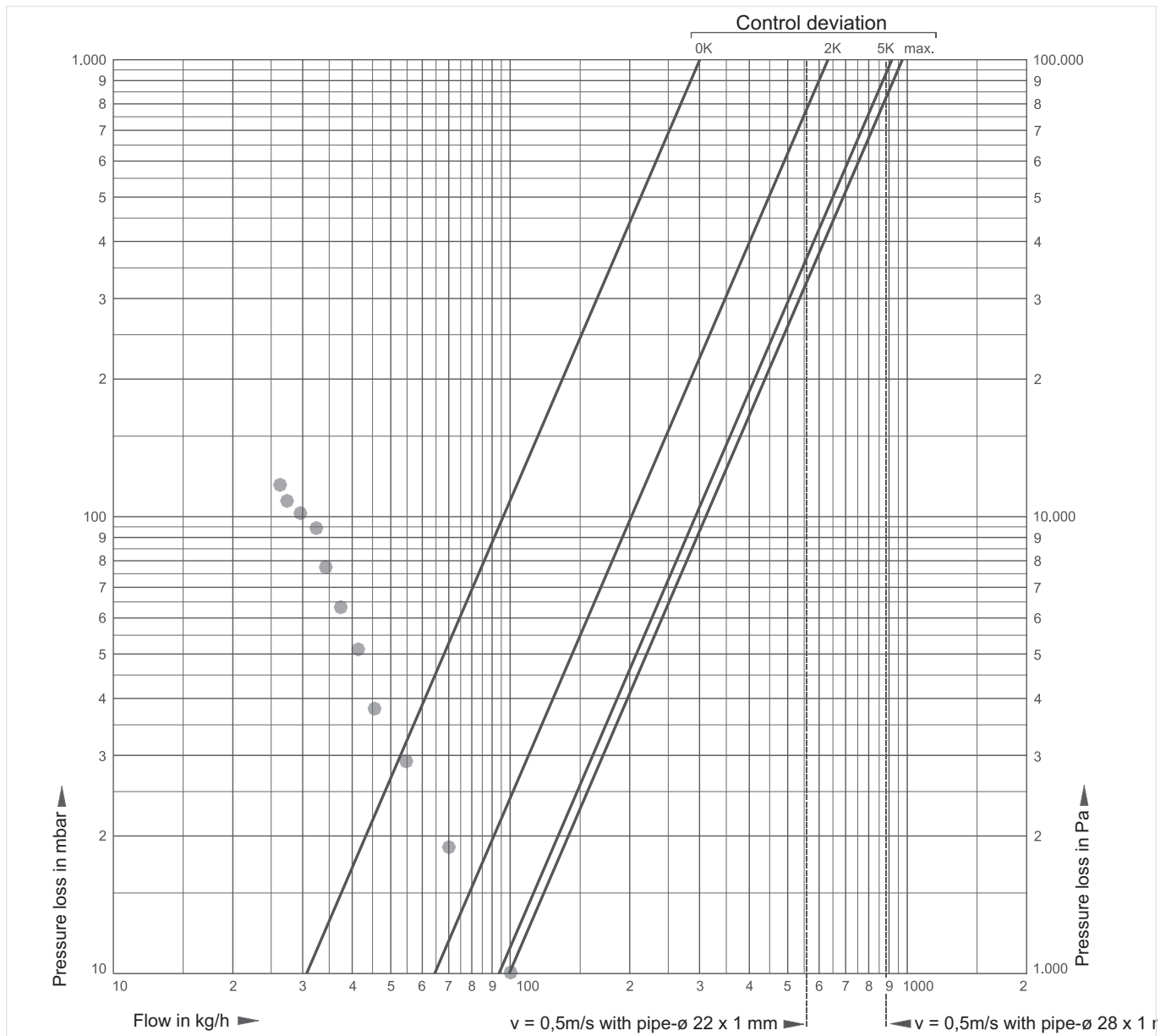

- Throttle position according to calculation example 3 of DVGW worksheet W553 (multi storey building with 48 flats)

Presetting:	0.5	0.7	1.0	1.2	1.5	2.0
k_{VS} -value:	40	45	50	55	60	65

Note: Due to manufacturing reasons the closes position (shut-off) is already reached between presetting 0.2 and 0.4.

Flow Data for DN32 and DN40 with thermal actuator 40 - 65°C

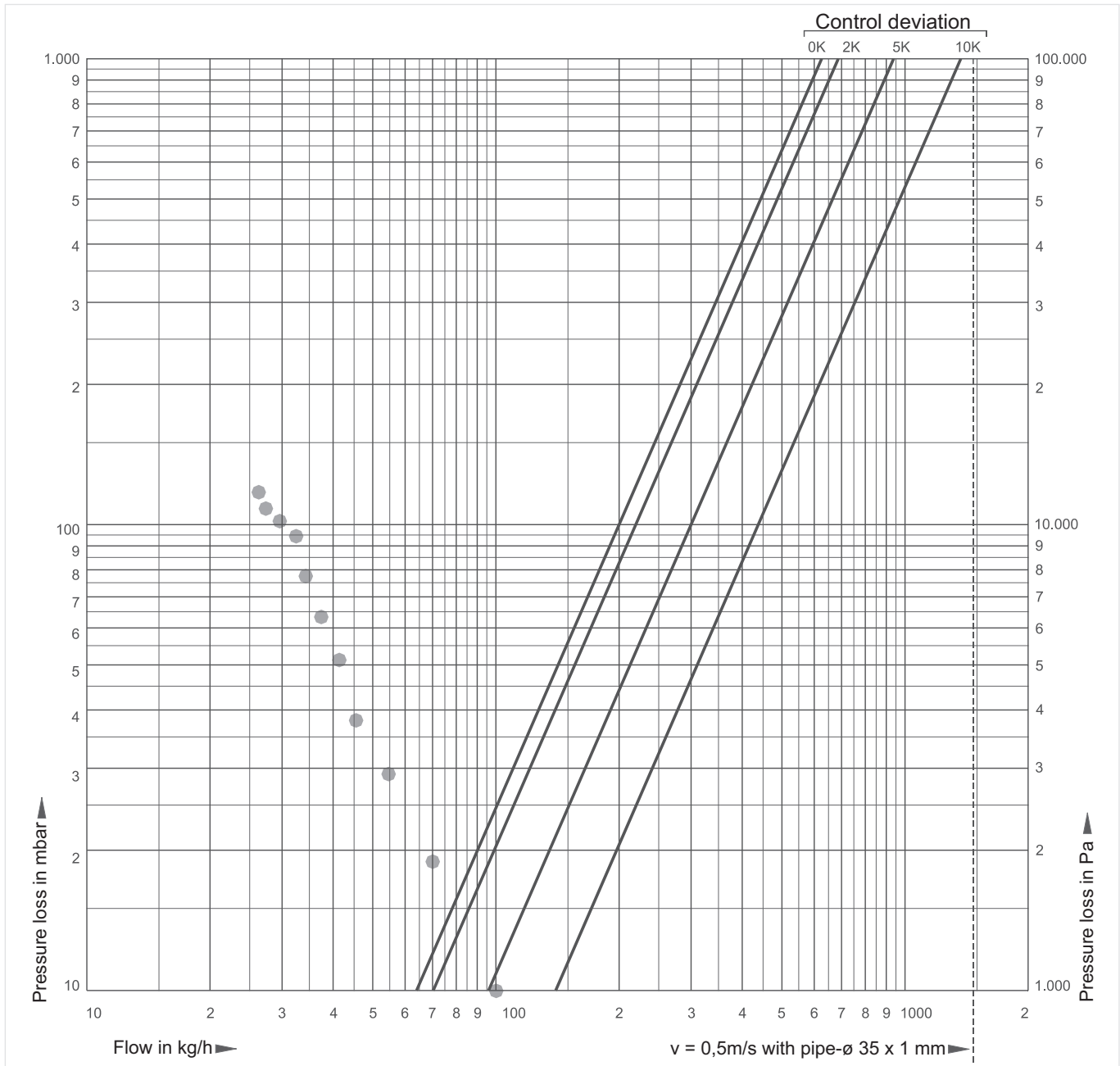

- Throttle position according to calculation example 3 of DVGW worksheet W553 (multi storey building with 48 flats)

Presetting:	0.5	0.7	1.0	1.2	1.5	2.0
k_{VS} -value:	40	45	50	55	60	65

Note: Due to manufacturing reasons the closes position (shut-off) is already reached between presetting 0.2 and 0.4.

DIMENSIONS

Alwa-Kombi-4 with internal and external threads

Overview

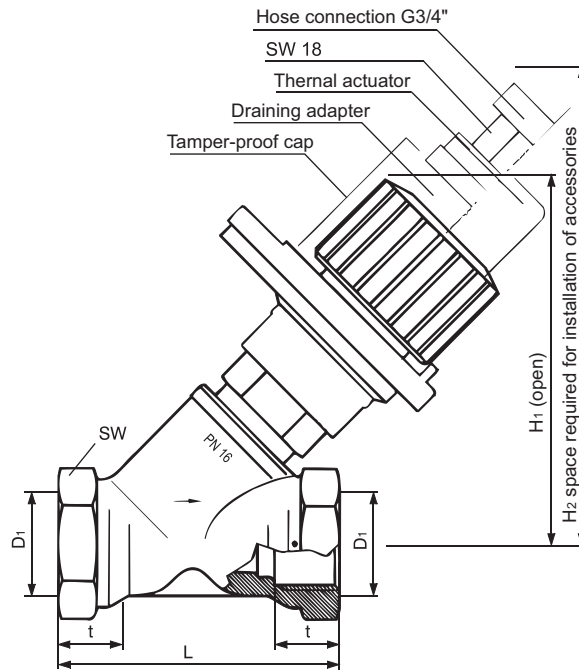

Parameter	Values					
Connection size:	DN	15	20	25	32	40
k_{vs} (C_{vs})-value:	m^3/h	2.7	6.4	6.8	16.0	16.0
Dimensions:	D1	Rp 1/2"	Rp 3/4"	Rp 1"	Rp 1 1/4"	Rp 1 1/2"
	L	65	75	90	110	120
	H1	85	100	100	137	137
	H2	135	150	150	210	210
	SW	27	32	41	50	55

Note: All dimensions in mm unless stated otherwise.

Alwa-Kombi-4 with external threads

Overview

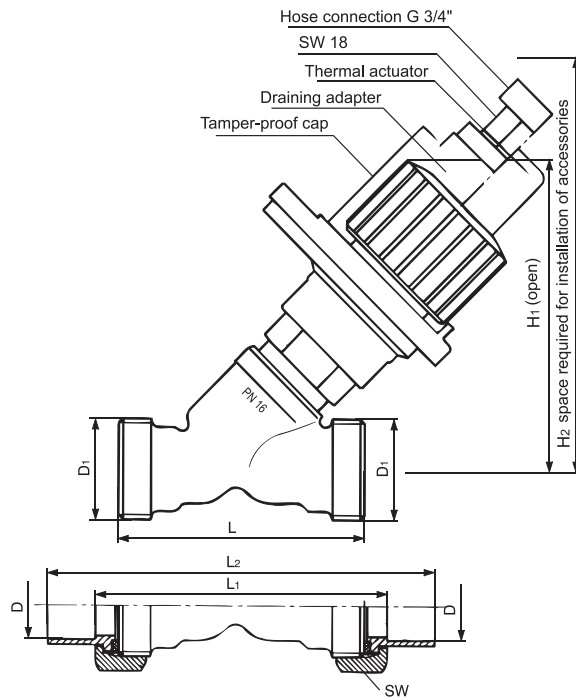

Parameter	Values					
Connection size:	DN	15	20	25	32	40
k_{VS} (C_{VS})-value:	m^3/h	2.7	6.4	6.8	16.0	16.0
Dimensions:	D1	G ³ / ₄ \"A	G 1\"A	G1 ¹ / ₄ \"A	G1 ¹ / ₂ \"A	G1 ³ / ₄ \"A
	D2	15/18	22	28	35	42
	L	65	75	90	110	120
	L1	81	91	108	128	140
	L2	105	125	148	178	198
	H1	85	100	100	137	137
	H2	135	150	150	210	210
	SW	30	37	47	52	60

Note: All dimensions in mm unless stated otherwise.

Thermal actuator for Alwa-Kombi-4

Overview

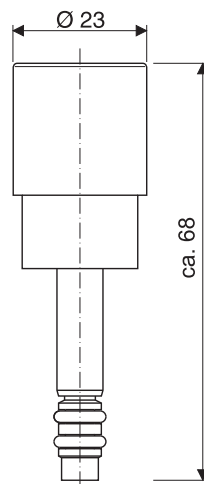

Note: All dimensions in mm unless stated otherwise.

ORDERING INFORMATION





The following tables contain all the information you need to make an order of an item of your choice. When ordering, please always state the type, the ordering or the part number.





Options

Version:	OS.-No.:	DN:	15	15	20	25	32	40
		mm:	15	18	22	28	35	42
		R:	1/2"	1/2"	3/4"	1"	1 1/4"	1 1/2"
Alwa-Kombi-4 throttle valve with internal threads	V1810Y0	015	-	020	025	032	040	
Alwa-Kombi-4 throttle valve with internal threads and fitted 'Mapress' press-fittings	V1816Y0	015	018	020	025	032	040	
Alwa-Kombi-4 throttle valve with internal threads and fitted 'Sanpress' press-fittings	V1817Y0	015	018	020	025	032	040	
Alwa-Kombi-4 throttle valve with external threads	V1810X0	015	-	020	025	-	-	

Note: Add desired size to OS-No.: V1810X0 in DN15 = V1810X0015

Accessories

	Description	Dimension	Part No.
	VA7401 Union nut, sealing and red bronze tailpiece for external threads		
		DN15	VA7400A015
		DN15	VA7400A016
		DN20	VA7400A018
		DN20	VA7400A020
		DN25	VA7400A025
		DN32	VA7400A032
	DN40	VA7400A040	
	VA7401 Union nut, sealing and externally threaded red bronze tailpiece for external threads		
		DN15	VA7401A015
		DN20	VA7401A020
		DN25	VA7401A025
		DN32	VA7401A032
	DN40	VA7401A040	
	VA7403 Union nut with Mapress-fitting for external threads		
	For pipe-Ø 15 mm	DN15	VA7403A015
	For pipe-Ø 18 mm	DN15	VA7403A018
	For pipe-Ø 22 mm	DN20	VA7403A020
	For pipe-Ø 28 mm	DN25	VA7403A025
	For pipe-Ø 35 mm	DN32	VA7403A032
	For pipe-Ø 42 mm	DN40	VA7403A040
	VA3400 Draining adapter		
		for all types and sizes	VA3400A001
	VA7404 Sanpress red bronze crimp fitting with sealing		
	For pipe-Ø 15 mm	DN15	VA7404A015
	For pipe-Ø 18 mm	DN15	VA7404A018
	For pipe-Ø 22 mm	DN20	VA7404A020
	For pipe-Ø 28 mm	DN25	VA7404A025
	For pipe-Ø 35 mm	DN32	VA7404A032
	For pipe-Ø 42 mm	DN40	VA7404A040

	VA7405	Union nut, sealing and internally threaded red bronze tailpiece		
			DN15	VA7405A015
			DN20	VA7405A020
			DN25	VA7405A025
			DN32	VA7405A032
		DN40	VA7405A040	
	VA2400	Thermal actuator		
		Temperature setting range 50 - 60 °C (122-140 °F)	all sizes	VA2400A002
		Temperature setting range 40 - 65 °C (104-149 °F)	all sizes	VA2400B002
	TH07K	Thermometer		
		Note: Thermometer TH07K cannot be used in combination with thermal actuators VA2400A002 and VA2400B002		
		Temperature range 0 - 120 °C, tolerance +2 K / -5 K	for all sizes	TH07K
	VA3400	Sampling valve		
		only in conjunction with drain adapter VA3400A001	for all sizes	VA3400C001